

MASTER DIRECTORY 2023

ALUMINUM EQUIPMENT SUPPLIERS



LIGHT METAL AGE

PRIMARY • EXTRUSION • SECONDARY • FLAT ROLLED



- ✓ SINGLE CHAMBER / MULTI CHAMBER FURNACES
- ✓ SCRAP DECOATING SYSTEMS
- ✓ TILTING ROTARY MELTING FURNACES
- ✓ SCRAP CHARGING MACHINES
- ✓ LAUNDRY SYSTEMS
- ✓ CASTING / HOLDING FURNACES
- ✓ HOMOGENIZING OVENS
- ✓ COOLERS
- ✓ SOW PRE-HEATERS
- ✓ REPAIR & ALTERATIONS

*Integrating
Science & Art
for Over 80
Years*



Gillespie & Powers, Inc.

ST. LOUIS, MISSOURI, USA

800-325-7075 | www.gillespiepowers.com | 314-423-9460

Master Directory 2023

a publication of

LIGHT METAL AGE

Directories:

- Index to Directory of Primary Aluminum Equipment Manufacturers & Suppliers 4
- Index to Directory of Aluminum Extrusion Equipment Manufacturers and Suppliers 12
- Index to Directory of Secondary Aluminum Equipment Manufacturers & Suppliers 26
- Index to Directory of Flat Rolled Aluminum Equipment Manufacturers and Suppliers 34
- Alphabetical List of Companies 41

Advertiser Index

| | | | |
|---|-------|-----------------------------------|----|
| Almex USA | 5 | Lyng Drilling | 11 |
| Belco | 15 | Mechatherm..... | 31 |
| Castool | 3, 12 | Novatec Innovative Solutions..... | 21 |
| Chiz Bros | 56 | Prezezzi | 23 |
| Die Cleaning Equipment & Supply LLC | 19 | Refractory Technology | 53 |
| Dunaway..... | 25 | SECO/Warwick..... | 27 |
| ExtrusionSupplies..... | 45 | Sensory Analytics | 35 |
| Gillespie & Powers | 2 | Thorpe Technologies..... | 49 |
| GLAMA | 47 | Turla-RFK | 13 |
| Granco Clark | 17 | US Controls | 37 |
| Inductotherm..... | 29 | Zmag America, Ltd..... | 55 |



COVER: The 180,000 lb tilting dry hearth melting furnace supplied by Gillespie & Powers (G&P) to the newest Matalco facility in Franklin, KY, is equipped with an intelligent regenerative combustion system, which is recognized as having the industry's most advanced, energy-efficient, and emission-compliant technology. The furnace can melt over 52,000 lbs of cold scrap aluminum per hour. (Photo: Ryan Marsh, ryanmarsh.photographer@gmail.com.)

The **Master Directory 2023** is an up-to-date database of nearly 350 supplier companies. It is the aluminum industry's best resource for finding equipment, products, and services. It is organized by four industry sectors—Primary Aluminum, Aluminum Extrusion, Secondary Aluminum, and Flat Rolled Aluminum. This directory was updated June 2023. The directory is available in print (\$20) and online (free of charge) at: www.lightmetalage.com/suppliers.

LIGHT METAL AGE magazine is published bi-monthly by Fellom Publishing Co., 170 South Spruce Avenue, Suite 120, South San Francisco, CA 94080-4519. **MAGAZINE SUBSCRIPTION RATES 2023, Hard Copy:** 1 year—\$63.00; 2 years—\$73.00; 3 years—\$84.00. Surface mail rates, 1 year—\$105.00; 2 years—\$152.00; 3 years—\$205.00. Airmail rates, 1 year—\$142.00; 2 years—\$226.00; 3 years—\$315.00. Digital: 1 Year—\$41.00. Back issues \$12.00 each plus postage. Special single copy prices for large directory issues—\$15.00 plus postage.

lma@lightmetalage.com • www.lightmetalage.com • ☎ (650) 588-8832

Copyright © 2023 by Fellom Publishing/Light Metal Age. All rights reserved.

BETTER PROFILES FASTER

DIRECT TOOLING

DUMMY BLOCKS

INDIRECT TOOLING

H-13 [1.2344] AND TUFF-TEMPER

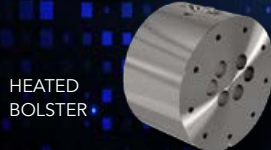
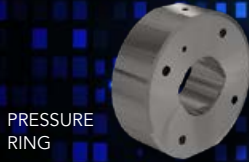

TOOLING SPECIALISTS

Relines
Stems
Clean-Out Blocks
Shear Blades

Billet Shears
Die Rings (Reclaimed)
Piercing Mandrels
Indirect Tooling

CASTOOL
TOOLING SYSTEMS



sales@castool.com
www.castool.com



Index to Directory of Primary Aluminum Equipment Manufacturers & Suppliers

ANODE PLANT

| | |
|--|---|
| Anode Baking Furnaces | 6 |
| Anode Baking Furnace Ctrl Sys | 6 |
| Anode Charging Machines | 6 |
| Anode Cooling Systems | 6 |
| Anode Measuring Instruments | 6 |
| Anode Paste Mixers | 6 |
| Anode Plant Cleaning Systems | 6 |
| Anode Saws | 6 |
| Anode Slot Cutting Machines | 6 |
| Building Ventilation | 6 |
| Cranes/Furnace Cranes | 6 |
| Crushing Mills | 6 |
| Gas Cleaning Systems | 6 |
| Hammer Mills | 6 |
| Jaw Crushers | 6 |
| Proportioning Systems | 6 |
| Refractories | 6 |
| Vibrating Compactors/ Forming Machines | 6 |

ANODE RODDING PLANT

| | |
|-----------------------------------|---|
| Anode Assembly Machines | 6 |
| Anode Cleaning Systems | 6 |
| Anode Rods | 6 |
| Bath Material Removal Sys | 6 |
| Building Ventilation | 6 |
| Butt Cleaning Machines | 6 |
| Butt Crushing Machines | 6 |
| Butt Stripping Machines | 6 |
| Cast Iron Pouring Stations | 6 |
| Cathode Sealing Systems | 6 |
| Induction Furnaces | 6 |
| Pollution Control Equipment | 6 |
| Rod Grinding Machines | 6 |
| Rod Straightening Machines | 7 |
| Shot Blasting Stations | 7 |
| Stub Coatings/Coating Units | 7 |
| Stub Cutting Machines | 7 |
| Stub Drying Units | 7 |
| Stub Hole Boring Machines | 7 |
| Stub Protection Systems | 7 |
| Stub Straightening Machines | 7 |
| Stub Welding Machines | 7 |
| Thimble Removal Presses | 7 |

POTROOM

| | |
|------------------------------------|---|
| Alumina Conveyors | 7 |
| Alumina Feeders | 7 |
| Aluminum Siphoning Systems | 7 |
| Anode Transporters | 7 |
| Bath Cleaning Machines | 7 |
| Building Ventilation | 7 |
| Bulk Material Carriers | 7 |
| Busbars and Flexibles | 7 |
| Cell Carbon Lining Materials | 7 |
| Crucible Cleaning Machines | 7 |
| Crust Breakers | 7 |
| Hammer Breakers | 7 |
| Metal Transfer Ladles | 7 |
| Pollution Control Equipment | 7 |
| Pot Bake Out Systems | 7 |
| Pot Cells | 7 |
| Pot Ramming | 7 |
| Pot Superstructures | 7 |
| Potline Insulation | 7 |

| | |
|----------------------------------|---|
| Potroom Cleaning Equipment | 7 |
| Potroom Vehicles | 7 |
| Refractories | 8 |
| Spading Machines | 8 |
| Tapping Machines | 8 |
| Vacuum Cleaners | 8 |

CASTHOUSE

| | |
|--|----|
| Alloying Elements | 8 |
| Building Ventilation | 8 |
| Casthouse Cranes | 8 |
| Casthouse Lubricants | 8 |
| Chip Melters | 8 |
| Combustion Equipment | 8 |
| Continuous Rod Casters | 8 |
| Continuous Sheet Casters | 8 |
| Continuous Thin Slab Casters | 8 |
| DC Casting Machine Automation | 8 |
| DC Casting Machines | 8 |
| Dross Cooling Equipment | 8 |
| Dross Removal Equipment | 8 |
| Flux | 8 |
| Furnace Charging Machines | 8 |
| Furnace Tending/Skimming Machines | 9 |
| Furnaces – Homogenizing | 9 |
| Furnaces – Induction | 9 |
| Furnaces – Melting/Holding | 9 |
| Grain Refining Alloys | 9 |
| Grain Refining Rod Dispensers | 9 |
| Graphite Machine Parts | 9 |
| Horizontal Casting Machines | 9 |
| Hydrogen Analyzers | 9 |
| Immersion Heaters | 9 |
| Industrial Gases | 9 |
| Ingot Casting Machines | 9 |
| Ingot Handling/Stacking Equipment | 9 |
| Laser Marking/Traceability | 10 |
| Launders and Troughs | 10 |
| Material Handling Equipment/Vehicles | 10 |
| Metal Degassing Equipment/Supplies | 10 |
| Metal Filtration Equipment | 10 |
| Metal Pretreatment Equipment | 10 |
| Metal Skimming | 10 |
| Mold Tooling – Billet, Slab, T-Ingot | 10 |
| Molten Level Control/Instrumentation | 10 |
| Molten Metal Analysis | 10 |
| Molten Metal Pumps | 10 |
| Pollution Control Equipment | 10 |
| Refractories/Coatings | 10 |
| Sawing Machines/Consumables | 10 |
| Sow Casters | 11 |
| Stirrers – Electromagnetic | 11 |
| Stirrers – Permanent Magnet | 11 |
| Strapping/Packaging Equipment | 11 |
| Temperature Measurement | 11 |
| Ultrasonic Testing | 11 |

SMELTER SERVICES

| | |
|--------------------------------------|----|
| Consultants (Primary Business) | 11 |
| Publications | 11 |
| Smelter By-Product Treatment | 11 |
| Technical Services | 11 |

USED EQUIPMENT

| | |
|--------------------------|----|
| (Primary Business) | 11 |
|--------------------------|----|



WE DESIGN AND BUILD ALUMINUM CASTHOUSES WORLDWIDE

**Our knowledge is cast in aluminum.
Our relationships are cast in stone.**

ONLY Almex offers comprehensive guarantees:

- Casthouse Equipment Machine Warranty
- Casting Process Performance Warranty
- Cast Product Quality Warranty
- End Product Quality Warranty



Furnace to Finish™ Aluminum Casthouse Solutions

www.almexusa.com

Directory of Primary Aluminum Equipment Manufacturers & Suppliers Categories/Companies

ANODE PLANT

Anode Baking Furnace Ctrl Sys

Fives Solios
Innovatherm
Janus Automation, LLC
R&D Carbon Ltd.
Riedhammer GmbH

Anode Baking Furnaces

Chiz Bros.
Major Furnace Australia
Riedhammer GmbH

Anode Charging Machines

Buss ChemTech AG
GLAMA Maschinenbau GmbH
Hencon B.V.
Riedhammer GmbH

Anode Cooling Systems

Buss ChemTech AG
EPIQ Machinery
Fives Solios

Anode Measuring Instruments

Buss ChemTech AG
R&D Carbon Ltd.

Anode Paste Mixers

Buss ChemTech AG
Eirich
Fives Solios
Haarslev Industries Press
Technology

Anode Plant Cleaning Systems

Buss ChemTech AG
EPIQ Machinery
SERMAS

Anode Saws

EPIQ Machinery
Friggi America
IMPEC AS
Lyng Drilling AS
August Mössner GmbH + Co. KG
Riedhammer GmbH
SERMAS

Anode Slot Cutting Machines

EPIQ Machinery
IMPEC AS
Lyng Drilling AS
T.T. Tomorrow Technology S.p.A.

Building Ventilation

Air-Therm Inc.
CECO Busch

Cranes/Furnace Cranes

Fives ECL
Riedhammer GmbH

Crushing Mills

Buss ChemTech AG
Fives Solios
IMPEC AS

Gas Cleaning Systems

Buss ChemTech AG
Entecco Filter Technology
Fives Solios
Innovatherm

Hammer Mills

Buss ChemTech AG
IMPEC AS

Jaw Crushers

Buss ChemTech AG
Fives Solios
IMPEC AS

Proportioning Systems

Buss ChemTech AG

Refractories

Calderys
Chiz Bros.
GES-AGM USA
Gillespie & Powers, Inc.
Kabert Industries
Plibrico Company, LLC
Pyrotek
Riedhammer GmbH
Thorpe Technologies Inc.
Wahl Refractory Solutions, LLC

Vibrating Compactors/ Forming Machines

Ajax/CECO/Erie Press
Buss ChemTech AG
Fives Solios

ANODE RODDING PLANT

Anode Assembly Machines

EPIQ Machinery
Fives ECL
IMPEC AS

Anode Cleaning Systems

Buss ChemTech AG
EPIQ Machinery
Fives ECL
GLAMA Maschinenbau GmbH
IMPEC AS
Laserax
Lyng Drilling AS
SERMAS
STAS
Techmo Car SpA
T.T. Tomorrow Technology S.p.A.

Anode Rods

EPIQ Machinery
HMR Group AS
IMPEC AS
Pyrotek

Bath Material Removal Sys.

EPIQ Machinery
GLAMA Maschinenbau GmbH
IMPEC AS
Techmo Car SpA

Building Ventilation

Air-Therm Inc.
CECO Busch
Entecco Filter Technology USA

Butt Cleaning Machines

Buss ChemTech AG
EPIQ Machinery
Fives ECL
GLAMA Maschinenbau GmbH
HMR Group AS
IMPEC AS
SERMAS
Techmo Car SpA

Butt Crushing Machines

Buss ChemTech AG
EPIQ Machinery
IMPEC AS
SERMAS
Techmo Car SpA

Butt Stripping Machines

EPIQ Machinery
Fives ECL
IMPEC AS

Cast Iron Pouring Stations

EPIQ Machinery
IMPEC AS

Cathode Sealing Systems

EPIQ Machinery
SERMAS

Induction Furnaces

Calderys
IMPEC AS
Inductotherm Corp.

Pollution Control Equipment

Air-Therm Inc.
Entecco Filter Technology USA
Major Furnace Australia
Pyrotek
Stelter & Brinck

Rod Grinding Machines

EPIQ Machinery
IMPEC AS

Directory of Primary Aluminum Equipment Manufacturers & Suppliers Categories/Companies

Rod Straightening Machines

EPIQ Machinery
IMPEC AS

Shot Blasting Stations

EPIQ Machinery
Fives ECL
Friggi America
IMPEC AS
STAS
Techmo Car SpA

Stub Coatings/Coating Units

Bawtry Carbon International
EPIQ Machinery
IMPEC AS
Pyrotek
Scottish Chemical Industries

Stub Cutting Machines

EPIQ Machinery
HMR Group AS
IMPEC AS

Stub Drying Units

EPIQ Machinery
IMPEC AS
Major Furnace Australia

Stub Hole Boring Machines

EPIQ Machinery
Lyng Drilling AS

Stub Protection Systems

IMPEC AS

Stub Straightening Machines

EPIQ Machinery
IMPEC AS

Stub Welding Machines

EPIC Machinery
HMR Group AS
IMPEC AS

Thimble Removal Presses

EPIQ Machinery
IMPEC AS

POTROOM

Alumina Conveyors

Daifuku America Corporation
Hencan B.V.
Mansell and Associates

Alumina Feeders

GLAMA Maschinenbau GmbH
Hencan B.V.
HMR Group AS
IMPEC AS
Mansell and Associates
Techmo Car SpA

Aluminum Siphoning Systems

EPIQ Machinery
Hencan B.V.
HMR Group AS
Major Furnace Australia

Anode Transporters

EPIQ Machinery
GLAMA Maschinenbau GmbH
Hencan B.V.
HMR Group AS
Techmo Car SpA
T.T. Tomorrow Technology S.p.A.

Bath Cleaning Machines

EPIQ Machinery
Hencan B.V.
IMPEC AS
Techmo Car SpA

Building Ventilation

Air-Therm Inc.
Entecco Filter Technology USA
Major Furnace Australia

Bulk Material Carriers

EPIQ Machinery
T.T. Tomorrow Technology S.p.A.

Busbars and Flexibles

HMR Group AS
IMPEC AS

Cell Carbon Lining Materials

Bawtry Carbon International Ltd.
GES-AGM USA, Inc.

Crucible Cleaning Machines

EPIQ Machinery
Hencan B.V.
HMR Group AS
IMPEC AS
Mansell and Associates
STAS
Techmo Car SpA

Crust Breakers

EPIQ Machinery
GLAMA Maschinenbau GmbH
Hencan B.V.
HMR Group AS
IMPEC AS
Pyrotek
Techmo Car SpA

Hammer Breakers

GLAMA Maschinenbau GmbH
Hencan B.V.
HMR Group AS
Techmo Car SpA

Metal Transfer Ladles

Conticast Hormesa LLC
EPIQ Machinery
Gillespie & Powers, Inc.
GLAMA Maschinenbau GmbH
Hencan B.V.
HMR Group AS
Mansell and Associates
Presezzi Extrusion – Melting
Technology
Pyrotek
Scottish Chemical Industries
Techmo Car SpA
Thorpe Technologies Inc.
T.T. Tomorrow Technology S.p.A.
Wahl Refractory Solutions, LLC

Pollution Control Equipment

Air-Therm Inc.
Entecco Filter Technology
Fives Solios
Mansell and Associates
O2 Environmental Technologies Inc.
Pyrotek

Pot Bake Out Systems

HCT, part of Bloom Engineering

Pot Cells

AluCellTech Inc.
HMR Group AS

Pot Ramming

Bawtry Carbon International
EPIQ Machinery
IMPEC AS
STAS
Wahl Refractory Solutions, LLC

Pot Superstructures

IMPEC AS

Potline Insulation

Gillespie & Powers, Inc.
The Gund Company, Inc.
Pyrotek
Thorpe Technologies Inc.

Potroom Cleaning Equipment

EPIQ Machinery
Fives Solios
Hencan B.V.
STAS
Techmo Car SpA

Potroom Vehicles

EPIQ Machinery
GLAMA Maschinenbau GmbH
Hencan B.V.
HMR Group AS
Techmo Car SpA

Directory of Primary Aluminum Equipment Manufacturers & Suppliers Categories/Companies

Refractories

Calderys
Chiz Bros.
GES-AGM USA, Inc.
Gillespie & Powers, Inc.
Plibrico Company, LLC
Pyrotek
Scottish Chemical Industries
Thorpe Technologies Inc.
Wahl Refractory Solutions, LLC

Spading Machines

Hencon B.V.
HMR Group AS

Tapping Machines

EPIQ Machinery
GLAMA Maschinenbau GmbH
Hencon B.V.
HMR Group AS
Pyrotek
Techmo Car SpA

Vacuum Cleaners

Hencon B.V.
STAS
Techmo Car SpA

CASTHOUSE

Alloying Elements

Excellent Foundry Fluxes Company
Scottish Chemical Industries

Building Ventilation

Air-Therm Inc.
Entecco Filter Technology
Major Furnace Australia

Casthouse Cranes

Castal Engineering
EPIQ Machinery

Casthouse Lubricants

AMCOL Corporation
Condat Lubricants
Pyrotek
Scottish Chemical Industries
ZIRCAR Ceramics, Inc.

Chip Melters

ALTEK
ANDRITZ Metals USA Inc.
CitiUS Muhendislik
Conticast Hormesa LLC
Fives North American Combustion
GHI Hornos Industriales SA
Gillespie & Powers, Inc.
GNA alutech inc.
Hertwich Engineering
HOWDEN Canada
Inductotherm Corp
Mechatherm International Ltd.

Presezzi Extrusion – Melting
Technology
Pyrotek
Sistem Teknik Industrial Furnaces Ltd.
Thorpe Technologies Inc.
Zmag America, Ltd.

Combustion Equipment

Airgas, an Air Liquide Company
Air Products
ANDRITZ Metals USA Inc.
Bloom Engineering
Castal Engineering
CETAG
CitiUS Muhendislik
Conticast Hormesa LLC
Fives North American Combustion
Gautschi Engineering GmbH
Gillespie & Powers, Inc.
HCT, part of Bloom Engineering
HOWDEN Canada
Innovatherm
Major Furnace Australia
Mechatherm International Ltd.
Presezzi Extrusion – Melting
Technology
Sistem Teknik Industrial Furnaces Ltd.
Thorpe Technologies Inc.

Continuous Rod Casters

CitiUS-Muhendislik
Continuus-Properzi S.P.A.
Conticast Hormesa LLC
Dynamic Concept
Hazelett Corporation (Ebner Group)
Properzi International, Inc.
Southwire SCR Technologies

Continuous Sheet Casters

Castal Engineering
Conticast Hormesa LLC
Hazelett Corporation (Ebner Group)
Novelis PAE
Bruno Presezzi SpA
Sistem Teknik Industrial Furnaces Ltd.

Continuous Thin Slab Casters

Castal Engineering
Conticast Hormesa LLC
Hazelett Corporation (Ebner Group)

DC Casting Automation

Almex USA, Inc.
CitiUS Muhendislik
Conticast Hormesa LLC
Dynamic Concept
Gautschi Engineering GmbH
Hycast
Mechatherm International Ltd.
Novelis PAE
Precimeter Control AB
Sistem Teknik Industrial Furnaces
Wagstaff, Inc.

DC Casting Machines

Almex USA, Inc.
CitiUS Muhendislik
Conticast Hormesa LLC
Dynamic Concept
Gautschi Engineering GmbH
GHI Hornos Industriales SA
Hertwich Engineering
Hycast
Mechatherm International Ltd.
Novelis PAE
Wagstaff, Inc.

Dross Cooling Equipment

ALTEK
CETAG
Conticast Hormesa LLC
GHI Hornos Industriales SA
HMR Group AS
Kabert Industries
Mechatherm International Ltd.
Presezzi Extrusion – Melting
Technology
Pyrotek
Sanshin Industry Ltd.
STAS

Dross Removal Equipment

CETAG
Conticast Hormesa LLC
Dynamic Concept
EPIQ Machinery
GHI Hornos Industriales SA
GLAMA Maschinenbau GmbH
Hencon B.V.
Inductotherm Corp.
Mechatherm International Ltd.
Presezzi Extrusion – Melting
Technology
Pyrotek
Sanshin Industry Ltd.
Scottish Chemical Industries
T.T. Tomorrow Technology S.p.A.
Urja Products Pvt. Ltd.
Wahl Refractory Solutions

Flux

Almex USA, Inc.
Excellent Foundry Fluxes Company
Pyrotek
Scottish Chemical Industries
STAS

Furnace Charging Machines

CETAG
CitiUS Muhendislik
Conticast Hormesa LLC
EPIQ Machinery
Gautschi Engineering GmbH
GHI Hornos Industriales
Gillespie & Powers, Inc.
GLAMA Maschinenbau GmbH
GNA alutech inc.

Directory of Primary Aluminum Equipment Manufacturers & Suppliers Categories/Companies

Hencon B.V.
Hertwich Engineering
HOWDEN Canada
Mansell and Associates
Mechatherm International Ltd.
Prezezzi Extrusion – Melting
Technology
Pyrotek
Sistem Teknik Industrial Furnaces Ltd.
Techmo Car SpA
Thorpe Technologies Inc.
T.T. Tomorrow Technology S.p.A.

Furnace Tending/Skimming Machines

Almex USA Inc.
CitiUS Muhendislik
Conticast Hormesa LLC
EPIQ Machinery
GHI Hornos Industriales SA
Gillespie & Powers
GLAMA Maschinenbau GmbH
Hencon B.V.
HMR Group AS
Hertwich Engineering
Hycast
Mechatherm International Ltd.
Prezezzi Extrusion – Melting
Technology
Pyrotek
Sistem Teknik Industrial Furnaces
STAS
Techmo Car SpA
Thorpe Technologies Inc.
T.T. Tomorrow Technology S.p.A.

Furnaces – Homogenizing

Almex USA, Inc.
ANDRITZ Metals USA Inc.
CitiUS Muhendislik
Conticast Hormesa LLC
EFR - John Cockerill
EPCON Industrial Systems
Fives North American Combustion
Gautschi Engineering GmbH
GHI Hornos Industriales SA
Gillespie & Powers, Inc.
GNA alutech inc.
Hertwich Engineering
HOWDEN Canada
Major Furnace Australia
Mechatherm International Ltd.
Prezezzi Extrusion – Melting
Technology
SECO/Warwick Corp.
Sistem Teknik Industrial Furnaces
Surface Combustion, Inc.
Thorpe Technologies Inc.

Furnaces – Induction

Almex USA, Inc.
Conticast Hormesa LLC
Inductotherm Corp.

Marx GmbH & Co. KG

Furnaces – Melting/Holding

Almex USA, Inc.
ALTEK
ANDRITZ Metals USA Inc.
Castal Engineering
CETAG
CitiUS Muhendislik
Continuus-Properti S.P.A.
Dynamic Concept
EFR - John Cockerill
Fives North American Combustion
Gautschi Engineering GmbH
GHI Hornos Industriales SA
Gillespie & Powers, Inc.
GNA alutech inc.
Hertwich Engineering
HOWDEN Canada
Inductotherm Corp.
Lethiguel
Major Furnace Australia
Mansell and Associates
Mechatherm International Ltd.
Prezezzi Extrusion – Melting
Technology
Properzi International, Inc.
SECO/Warwick Corp.
Sistem Teknik Industrial Furnaces
Thorpe Technologies Inc.

Grain Refining Alloys

MQP Ltd.
Scottish Chemical Industries

Grain Refining Rod Dispensers

Almex USA, Inc.
CETAG
CitiUS Muhendislik
Gautschi Engineering GmbH
Hycast
Mechatherm International Ltd.
MQP Ltd.
Prezezzi Extrusion – Melting
Technology
Sistem Teknik Industrial Furnaces

Graphite Machine Parts

GES-AGM USA, Inc.
Graphite COVA GmbH
Lyng Drilling AS
Mersen USA GS Corp – Greenville
Molten Metal Equipment Innovations
Novelis PAE
Pyrotek
ZIRCAR Ceramics, Inc.

Horizontal Casting Machines

CitiUS Muhendislik
Conticast Hormesa LLC
Dynamic Concept
Gautschi Engineering
Hertwich Engineering

HOWDEN Canada
Novelis PAE
Prezezzi Extrusion – Melting
Technology
Worswick Engineering Ltd.

Hydrogen Analyzers

ABB Measurement & Analytics
Almex USA, Inc.
Molten Metal Equipment Innovations
Scottish Chemical Industries

Immersion Heaters

Atherm
Lethiguel
Pyrotek
Sistem Teknik Industrial Furnaces Ltd.

Industrial Gases

Airgas, an Air Liquide Company
Air Products

Ingot Casting Machines

Almex USA, Inc.
ALTEK
Castal Engineering
CitiUS Muhendislik
Conticast Hormesa LLC
Continuus-Properti S.P.A.
Dynamic Concept
EPIQ Machinery
GHI Smart Furnaces
Hertwich Engineering
Hycast
Mansell and Associates
Mechatherm International Ltd.
Prezezzi Extrusion – Melting
Technology
Properzi International, Inc.
Sistem Teknik Industrial Furnaces Ltd.
STAS
Wagstaff, Inc.

Ingot Handling/Stacking Equipment

Advanced Machine & Engineering
ALTEK
CitiUS Muhendislik
Continuus-Properti S.P.A.
EPIQ Machinery
GHI Hornos Industriales SA
Hencon B.V.
Mansell and Associates
Mechatherm International Ltd.
August Mössner GmbH & Co. KG
Prezezzi Extrusion – Melting
Technology
Properzi International, Inc.
SERMAS
Sistem Teknik Industrial Furnaces Ltd.
STAS

Directory of Primary Aluminum Equipment Manufacturers & Suppliers Categories/Companies

Laser Marking/Traceability

Advanced Technical Products
Dynamic Concept
EPIQ Machinery
Hertwich Engineering
Laserax
STAS

Launders and Troughs

Almex USA, Inc.
CETAG
CitiUS Muhendislik
Fives North American Combustion
Foundry Service and Supplies, Inc.
Gautschi Engineering GmbH
GHI Hornos Industriales SA
Gillespie & Powers, Inc.
Hycast
Mechatherm International Ltd.
Molten Metal Equipment Innovations
Presezzi Extrusion – Melting
Technology
Pyrotek
Refractory Technology LLC
Scottish Chemical Industries
STAS
Thorpe Technologies Inc.
Wagstaff, Inc.
Wahl Refractory Solutions, LLC

Material Handling Equipment/ Vehicles

Bradley Lifting Corp.
Combilift
Daifuku America Corporation
EPIQ Machinery
GLAMA Maschinenbau GmbH
Hencon B.V.
HMR Group AS
August Mössner GmbH & Co. KG
Techmo Car SpA

Metal Degassing Equipment/ Supplies

Airgas, an Air Liquide Company
Almex USA, Inc.
Conticast Hormesa LLC
Continuus-Properti S.P.A.
Excellent Foundry Fluxes Company
Hycast
Lethiguel
Molten Metal Equipment Innovations
Novelis PAE
Presezzi Extrusion – Melting
Technology
Properzi International, Inc.
Pyrotek
Scottish Chemical Industries
Sistem Teknik Industrial Furnaces Ltd.
Southwire SCR Technologies
STAS

Metal Filtration Equipment

Almex USA, Inc.
CitiUS Muhendislik
Conticast Hormesa LLC
Dynamic Concept
Hycast
Kabert Industries
Lethiguel
Molten Metal Equipment Innovations
Novelis PAE
Presezzi Extrusion – Melting
Technology
Properzi International, Inc.
Pyrotek
Scottish Chemical Industries
STAS
Urja Products Pvt. Ltd.

Metal Pretreatment Equipment

Conticast Hormesa LLC
GHI Hornos Industriales SA
Hycast
Kabert Industries
Pyrotek
STAS

Mold Tooling – Billet, Slab, T-Ingot

Almex USA, Inc.
Conticast Hormesa LLC
Dynamic Concept
Gautschi Engineering GmbH
Hycast
Pyrotek
STAS
Wagstaff, Inc.

Molten Level Control/ Instrumentation

Almex USA, Inc.
ANDRITZ Metals USA Inc.
Conticast Hormesa LLC
Dynamic Concept
Gillespie & Powers, Inc.
Hycast
Janus Automation, LLC
Mechatherm International Ltd.
Molten Metal Equipment Innovations
Precimeter Control AB
Precimeter Inc.
Presezzi Extrusion – Melting
Technology
Pyrotek
STAS
Thorpe Technologies Inc.
Wagstaff, Inc.

Molten Metal Analysis

ABB Measurement & Analytics
Almex USA, Inc.
ALTEK
Conticast Hormesa LLC
STAS

Molten Metal Pumps

ALTEK
CitiUS Muhendislik
Conticast Hormesa LLC
Dynamic Concept
GES-AGM USA
Hencon B.V.
Mechatherm International Ltd.
Molten Metal Equipment Innovations
Precimeter Control AB
Pyrotek
Sistem Teknik Industrial Furnaces
Zmag America, Ltd.

Pollution Control Equipment

Air-Therm Inc.
CECO Busch
Conticast Hormesa LLC
Entecco Filter Technology USA
EPCON Industrial Systems
Innovatherm
Major Furnace Australia
Mansell and Associates
Mechatherm International Ltd.
O2 Environmental Technologies Inc.
Presezzi Extrusion – Melting
Technology
Pyrotek

Refractories/Coatings

Advanced Technical Products
Almex USA, Inc.
Calderys
Chiz Bros.
Foundry Service and Supplies, Inc.
GES-AGM USA
Gillespie & Powers, Inc.
Graphite COVA GmbH
Kabert Industries
Mechatherm International Ltd.
Murlin Chemical
Plibrico Company, LLC
Presezzi Extrusion – Melting
Technology
Pyrotek
Refractory Technology, LLC
Scottish Chemical Industries
STAS
Thorpe Technologies Inc.
Wahl Refractory Solutions, LLC
ZIRCAR Ceramics, Inc.
ZYP Coatings, Inc.

Sawing Machines/Consumables

Advanced Dynamics Corp. Ltd.
Advanced Machine & Engineering
Behringer Saws
CitiUS Muhendislik
EPIQ Machinery
Friggi America
GHI Hornos Industriales SA
Hertwich Engineering
HOWDEN Canada
Mechatherm International Ltd.
August Mössner GmbH + Co. KG
SERMAS
Sistem Teknik Industrial Furnaces Ltd.
The L.S. Starrett Co.

Directory of Primary Aluminum Equipment Manufacturers & Suppliers Categories/Companies

Sow Casters

Dynamic Concept
EPIQ Machinery
GHI Hornos Industriales SA
Gillespie & Powers, Inc.
Hertwich Engineering
Mansell and Associates
STAS
Thorpe Technologies Inc.

Stirrers – Electromagnetic

ABB Inc.
ALTEK
GHI Hornos Industriales SA
Gillespie & Powers, Inc.
Mechatherm International Ltd.
Pyrotek
Thorpe Technologies Inc.

Stirrers – Permanent Magnet

Prezezzi Extrusion – Melting
Technology
Zmag America, Ltd.

Strapping/Packaging Equipment

HOWDEN Canada
August Mössner GmbH & Co. KG
Scottish Chemical Industries
STAS

Temperature Measurement

Accurate Sensors Technologies Ltd.
Almex USA, Inc.
AMETEK Land
Dynamic Concept
Gillespie & Powers, Inc.
Lethiguel
Mechatherm International Ltd.
Pyrotek
Thorpe Technologies Inc.
Williamson Corp.

Ultrasonic Testing

Almex USA, Inc.
CitiUS Muhendislik
Hertwich Engineering
HOWDEN Canada
Sistem Teknik Industrial Furnaces Ltd.

SMELTER SERVICES

Consultant (Primary Business)

Hatch
Oculatus Consulting
Ramboll
RFTS LLC
SCCR P/L
WorleyParsons Services Pty. Ltd.

Publications

The Aluminum Association
R&D Carbon Ltd.

TMS (The Minerals, Metals &
Materials Society)

Smelter By-Product Treatment

Regain Materials

Technical Services

AluCellTech Inc.
Buss ChemTech AG
EPIQ Machinery
Gillespie & Powers, Inc.
Hatch
Hencon B.V.
IMPEC AS
Innovatherm
Lyng Drilling AS
Pyrotek
R&D Carbon Ltd.
Riedhammer GmbH
SCCR P/L
Sistem Teknik Industrial Furnaces
Thorpe Technologies Inc.
Wahl Refractory Solutions, LLC

USED EQUIPMENT

(Primary Business)

Machinery International Corp.
Phipps Company

ISO-9001 CERTIFIED
business providing
PATENTED EQUIPMENT and TOOLS
for Anode Slotting,
Stub Hole Milling, and
Anode Cleaning for the
Aluminium Industry

Lyng Drilling

7125 Vanvikan, Norway
Email: lyngsales@slb.com
Tel: +47 74855550
<https://www.lyng-drilling.com/>



SCAN TO WATCH

Why you need Anode Slotting?

Index to Directory of Aluminum Extrusion Equipment Manufacturers and Suppliers

| | | | |
|---------------------------------------|----|--|----|
| Aging Ovens..... | 14 | Material Handling Equipment/Vehicles..... | 20 |
| Anodizing Chemicals..... | 14 | Metal Filters/Filtration Systems..... | 20 |
| Anodizing Systems..... | 14 | Metal Pumps..... | 20 |
| Automatic Profile Measurement..... | 14 | Nitriding Equipment..... | 20 |
| Belts..... | 14 | Non-Destructive Testing..... | 20 |
| Billet Casting Equipment..... | 14 | Packing Lines/Packaging..... | 20 |
| Billet Suppliers..... | 14 | Paint & Finishing Systems..... | 20 |
| Combustion Equipment (Burners)..... | 14 | PLCs..... | 20 |
| Compactors/Balers..... | 14 | Pollution Control Systems..... | 20 |
| Computer Systems/Software..... | 14 | Presses..... | 20 |
| Consultants (Primary Business)..... | 14 | Press Handling Systems & Materials..... | 20 |
| Container Heating Systems..... | 14 | Press Loading Equipment..... | 20 |
| CVD/PVD Coated Dies..... | 14 | Press Revamps/Replacement Parts..... | 22 |
| DC Power Supplies..... | 16 | Process Control & Automation Systems..... | 22 |
| Deburring Equipment..... | 16 | Profile Finishing Equipment..... | 22 |
| Degassing..... | 16 | Publications (Extrusion)..... | 22 |
| Die Cleaning Equipment..... | 16 | Pullers..... | 22 |
| Die Design..... | 16 | Quality Control Test Equipment..... | 22 |
| Die Ovens/Die Preheat Furnaces..... | 16 | Quenching Systems..... | 22 |
| Die Polishing Equipment..... | 16 | Racks/Stackers/Destackers..... | 22 |
| Die Storage Systems..... | 16 | Refractories..... | 22 |
| Dies..... | 16 | Rotary Extrusion Systems..... | 22 |
| Dross Treatment/Removal..... | 16 | Runout Rollers..... | 22 |
| Furnaces – Billet Heating..... | 16 | Saws/Saw Consumables..... | 22 |
| Furnaces – Heat Treating..... | 16 | Shears..... | 24 |
| Furnaces – Melting/Holding..... | 18 | Stirrers..... | 24 |
| Gas Suppliers/Systems..... | 18 | Stretchers/Straighteners..... | 24 |
| Grain Refining Rod Dispensers..... | 18 | Table Coolers/Fans..... | 24 |
| Graphite Machine Parts..... | 18 | Temperature Measurement Systems (Noncontact)..... | 24 |
| Hydraulic Systems (Presses)..... | 18 | Thermal Break Equipment..... | 24 |
| Hydrogen Analyzers..... | 18 | Tool Handling Equipment..... | 24 |
| Inclusion Measurement Systems..... | 18 | Tool Steels..... | 24 |
| Laser Marking/Traceability..... | 18 | Tooling..... | 24 |
| Lubricants/Lubrication Equipment..... | 18 | Equipment Agents / Used Equipment (Primary Business)..... | 24 |
| Maintenance..... | 18 | | |
| Master Alloys/Grain Refining..... | 18 | | |

BETTER PROFILES FASTER

QR CONTAINER

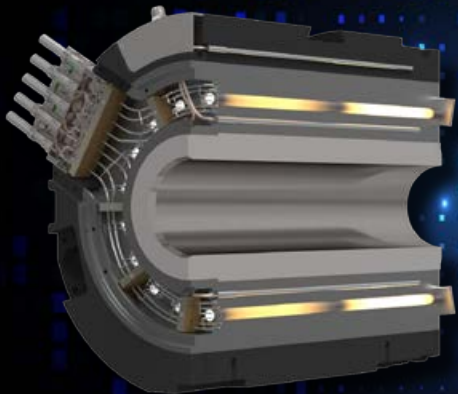

HPR DUMMY BLOCK



SINGLE CELL OVEN

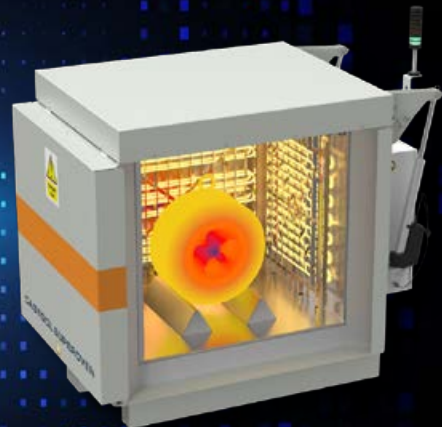

OPTIMIZATION

CASTOOL
TOOLING SYSTEMS



sales@castool.com
www.castool.com



TURLA

RFK

Powering the
Green Aluminium

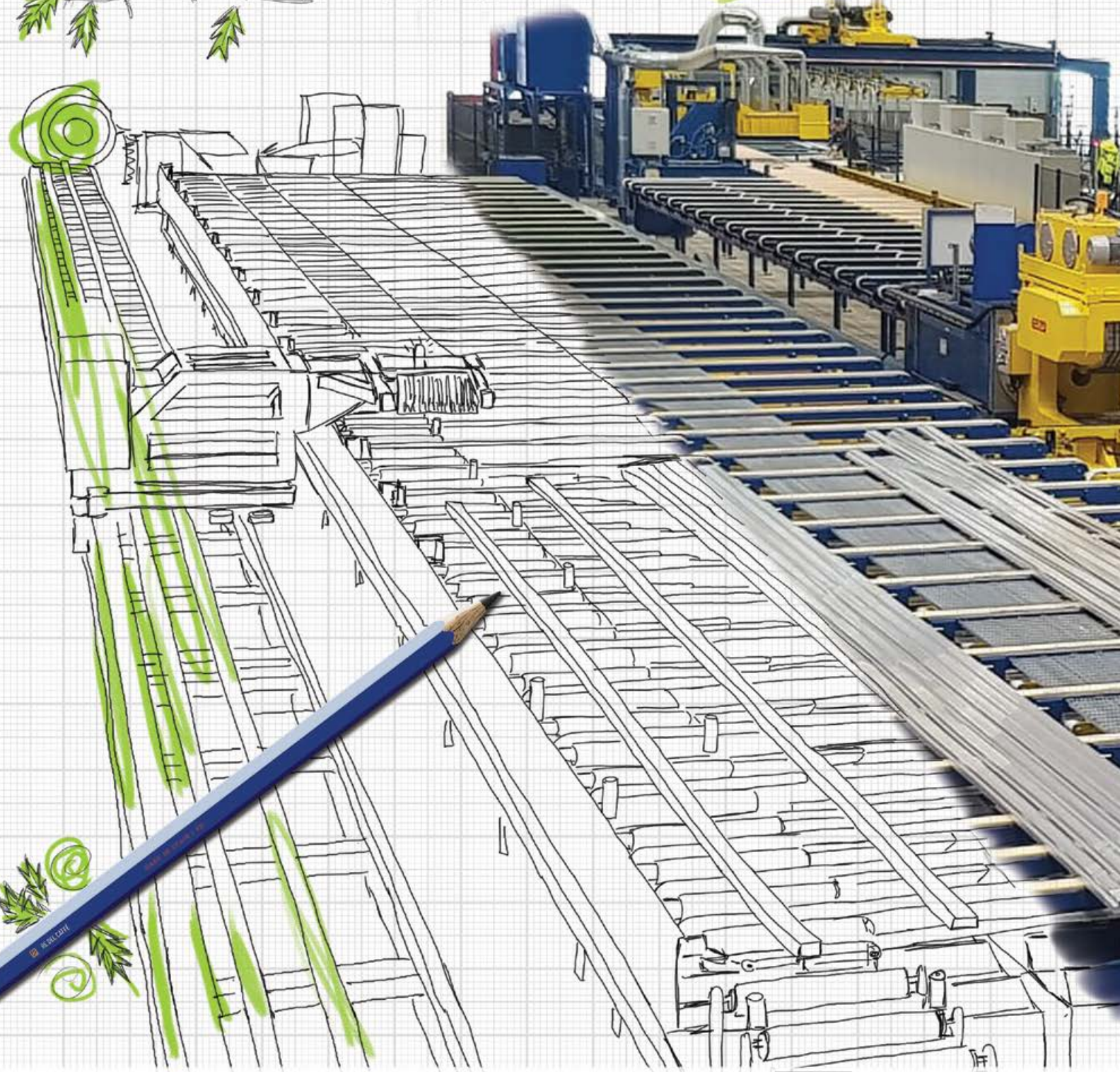

TURLA EXTRUSION PLANTS RFK S.R.L.

Via del Pavione 6/8, I-25050 Paderno FC (BS), Italy

Tel. +39.030.6857.555, sales@rfk-extrusion.com, www.rfk-extrusion.com



Follow us



Directory of Aluminum Extrusion Equipment Manufacturers and Suppliers Categories/Companies

AGING OVENS

ANDRITZ Metals USA Inc.
Belco Industries, Inc.
CitiUS Muhendislik
Chiz Bros
CNPT
COIM srl
Cometal Engineering SpA
Danieli Breda
Ebner Furnaces, Inc.
EPCON Industrial Systems
Extral Technology
extrutec GmbH
extrutec N.A. Inc.
Gerref Industries Inc.
GIA Clecim Press
GNA alutech inc.
Granco Clark Inc.
HOWDEN Canada
International Thermal Systems, LLC
Kautec Solutions
LOI Thermprocess GmbH
Major Furnace Australia
Mechatherm International Ltd.
OMAV S.p.A.
Presezzi Extrusion Group
Presezzi Extrusion – Melting
Technology
Presezzi Extrusion North America
SECO/Warwick Corp.
Sistem Teknik Industrial Furnaces Ltd.
Surface Combustion, Inc.
Turla Extrusion Plants RFK S.R.L.

ANODIZING CHEMICALS

Anodize USA
Clariant International Ltd.
Hubbard-Hall, Inc.
Italteco SRL
Quaker Houghton
Reliant Aluminum Products, LLC

ANODIZING SYSTEMS

Adwest Technologies, a CECO
Environmental Company
Anodizing Technologies Inc.
Anodize USA
Cometal Engineering SpA
ABD Equipment Co., Ltd.
GIA Clecim Press
Gramm Technik GmbH
Italteco SRL
N.T.K. Plants Management &
Business
SAT North America

AUTOMATIC PROFILE MEASUREMENT

Cometal
iNOEX LLC
Janus Automation LLC

BELTS

Albarrie Canada Limited
R.L. Best Company
Ecofill USA

Extral Technology
Ichikawa North America
Northern Innovations
OMAV S.P.A.
Presezzi Extrusion Group
Presezzi Extrusion North America
Tuff Temp Corp.

BILLET CASTING EQUIPMENT

Almex USA Inc.
ATM Atilim Teknik Makine
CitiUS Muhendislik
COIM Srl
Cometal Engineering SpA
Conticast Hormesa LLC
Dynamic Concept
GAP Engineering SA
Gautschi Engineering GmbH
GHI Smart Furnaces
Hertwich Engineering GmbH
HOWDEN Canada
HPI GmbH
Hycast
Mechatherm International Ltd.
Presezzi Extrusion Group
Presezzi Extrusion – Melting
Technology
Presezzi Extrusion North America
Sistem Teknik Industrial Furnaces Ltd.
SMS group GmbH
SMS group, Inc.
Wagstaff, Inc.

BILLET SUPPLIERS

AK Corporation
Alcoa USA Corp.
ELLWOOD Aluminum
Emirates Global Aluminium (EGA)
Hindalco Almex Aerospace Ltd.
Hydro Aluminum Metals USA, LLC
Matalco Inc.
Rio Tinto
Rusal America

COMBUSTION EQUIPMENT (BURNERS)

Airgas, An Air Liquide Company
Air Products
ANDRITZ Metals USA Inc.
Bloom Engineering
CETAG
COIM srl
CitiUS Muhendislik
Danieli Breda
Ebner Furnaces, Inc.
Fives North American Combustion
Gautschi Engineering GmbH
Gillespie & Powers
HCT, part of Bloom Engineering
International Thermal Systems
Major Furnace Australia
Mechatherm International Ltd.
Messer Americas
Presezzi Extrusion Group
Presezzi Extrusion North America
Sistem Teknik Industrial Furnaces Ltd.

Thorpe Technologies Inc.

COMPACTORS/BALERS

ATM Atilim Teknik Makine
COIM srl
GIA Clecim Press
Kautec Solutions
Macrodyne Press

COMPUTER SYSTEMS/ SOFTWARE

ALMAX MORI
ANDRITZ Metals USA Inc.
A.T.I.E Uno Informatica
Brilex Technical Solutions
Castool Tooling Systems
Cometal Engineering SpA
Foy Inc.
iNOEX LLC
Janus Automation LLC
KRAHE InfoSystems, Inc.
LOI Thermprocess GmbH
Presezzi Extrusion Group
Presezzi Extrusion – Melting
Technology
Presezzi Extrusion North America
QForm Group
Sistem Teknik Industrial Furnaces Ltd.
Turla Extrusion Plants RFK S.R.L.

CONSULTANTS (PRIMARY BUSINESS)

AluConsult
Aluminum Casting Technologies, LLC
Aluminum Extrusion Marketplace
Cji Systems
Cunningham Extrusion Services
EMV Technologies LLC
Innoval Technology Ltd.
Kennedy Eurotech Inc.
Long Point Associates
Metal Star Consulting LLC
Oculatus Consulting
Ramboll
RFTS LLC

CONTAINER HEATING SYSTEMS

Castool Tooling Systems
Cometal Engineering SpA
Gemini Group Extrusion Tooling
(GGT)
IAS GmbH
Lake Park Tool & Machine
Marx GmbH & Co. KG
Marx LLC
Presezzi Extrusion Group
Presezzi Extrusion North America
Southeastern Extrusion & Tool, Inc.

CVD/PVD COATED DIES

BOHLER
EDRO Specialty Steels
Ultra-Sonic Extrusion Dies Inc.
voestalpine eifeler coatings
WEFA Cedar Inc.

EXTRUSION EQUIPMENT



Our expertise focuses on extrusion systems for the aluminum industry, supplying furnaces, hot log saws, handling systems, die ovens, age ovens, and pullers to name a few. Customers looking for a total package solution to meet their specifications can count on Belco's complete turnkey systems. With every system or piece of equipment, we provide our customers with quality products, exceptional service, and on-time deliveries.

FURNACE EQUIPMENT

Belco has been on the cutting edge of furnace technological development for decades as the first to introduce and patent the four-hole probe and hot log saws. We provide custom sizes to meet your needs and requirements.

Billet/Log Loading Tables & Pusher Conveyor / Billet/Log Washer / Log Welders / Billet/Log Furnace / Hot Log Saws / Billet Transfer Conveyor / Billet End Lubricator

PRESS EQUIPMENT

As a system integrator, Belco is able to design, engineer, or manufacture accessories for your press from a wide variety of billet loader styles to the butt scrap conveyor.

Billet Loaders to Press Container / Billet Butt Conveyor / Nitrogen Gas Generator Units

HANDLING EQUIPMENT

Belco Industries is a leading manufacturer of aluminum extrusion handling systems that offers complete design engineering and installation services. With over 50 years of industry experience, we have designed and installed systems to handle all shapes and sizes of extrusions.

OVEN EQUIPMENT

Belco supplies a wide variety of ovens from small single cell die ovens to large heat treat ovens. Ovens are available with a choice of gas or electric heat.

DIE OVENS: Chest Type / Drawer Type / Single Cell Type / Die Storage Racks

AGE & ANNEALING OVENS: Single End Flow / Dual End Flow / Reversing End Flow / Cross or Side Flow

SUPPORT EQUIPMENT: Oven Conveyors / Oven Racks / Oven Carts / Rack Stacker

DIE CLEANING EQUIPMENT

Belco die cleaning systems are designed to allow the operator to place loaded baskets containing extrusion dies into the cleaning tank for the purpose of cleaning the aluminum from the steel die.

Automatic Die Cleaning Systems / Automatic Cranes for Die Cleaning Unit

PACKING LINE EQUIPMENT

Belco's packing lines are semi-automatic systems that will speed up the way material is packed. The system includes a banding station and bundle scale right in line with the equipment.

Adjustable Packing Stations / Driven Heavy Duty Roller Conveyor / Banding and Scales In-line / Rolldown Shipping Platform



ADDITIONAL EXTRUSION SOLUTIONS

Visit our website at: www.belcoind.com for more information on all of our extrusion solutions, including:

Extrusion Pullers / Run Out Equipment / Cooling Tables / Stretchers / Storage Tables / Saw Infeed Conveyors / Finish Saw & Gauge Tables / Lead Out Equipment

Directory of Aluminum Extrusion Equipment Manufacturers and Suppliers Categories/Companies

DC POWER SUPPLIES

ABB Inc.
Anodizing Technologies, Inc.
Italteco SRL

DEBURRING EQUIPMENT

Abtex, LLC.
Buelmann US LP
DUNAWAY

DEGASSING

Almex USA Inc.
ATM Atilim Teknik Makine
CitiUS Muhendislik
COIM srl
Conticast Hormesa LLC
Excellent Foundry Fluxes Company
Graphite COVA GmbH
Hertwich Engineering GmbH
Hycast
Mechatherm International Ltd.
Molten Metal Equipment Innovations
MQP Limited
Novelis PAE
Presezzi Extrusion Group
Presezzi Extrusion North America
Pyrotek Inc.
Scottish Chemical Industries
Sistem Teknik Industrial Furnaces Ltd.
Southwire SCR Technologies
STAS

DIE CLEANING EQUIPMENT

ALMAX MORI
Belco Industries, Inc.
Compes S.P.A.
Die Cleaning Equipment and
Supply Inc.
Gerref Industries Inc.
GIA Clecim Press
Gramm Technik GmbH
Italteco SRL
Presezzi Extrusion Group
Presezzi Extrusion North America

DIE DESIGN

Adex B.V.
ALMAX MORI
Castool Tooling Solutions
Compes International
Compes S.P.A.
Dienamex
Gemini Group Extrusion Tooling
(GGET)
GIA Clecim Press
Idamex S.A.
Phoenix International SpA
QForm Group
Southeastern Extrusion & Tool, Inc.
Thumb Tool & Engineering
Ultra-Sonic Extrusion Dies Inc.
WEFA Cedar Inc.
Youngstown Tool & Die Co. Inc.

DIE OVENS/DIE PREHEAT FURNACES

ANDRITZ Metals USA Inc.
Belco Industries, Inc.
Castool Tooling Systems
HOWDEN Canada
CitiUS Muhendislik
CNPT
COIM srl
Cometal Engineering SpA
Compes S.P.A.
Danieli Breda
extrutec GmbH
extrutec N.A. Inc.
Gerref Industries Inc.
GIA Clecim Press
Gillespie & Powers
Granco Clark Inc.
HOWDEN Canada
International Thermal Systems
Kautec Solutions
Major Furnace Australia
Marx GmbH & Co. KG
Marx LLC
Mechatherm International Ltd.
Novatec Innovative Systems
OMAV S.p.A.
Presezzi Extrusion Group
Presezzi Extrusion North America
SECO/Warwick Corp.
Sistem Teknik Industrial Furnaces Ltd.
Thermika Systems Inc.
Thorpe Technologies Inc.

DIE POLISHING EQUIPMENT

4 MI GmbH
ALMAX MORI
Compes S.P.A.
Gemini Group Extrusion Tooling
(GGET)

DIE STORAGE SYSTEMS

Belco Industries, Inc.
Castool Tooling Systems
Cometal Engineering SpA
Macrodyne Press
OMAV S.P.A.
Presezzi Extrusion Group
Presezzi Extrusion North America

DIES

Adex B.V.
ALMAX MORI
BOHLER
Compes International
Compes S.P.A.
Dienamex
EDRO Specialty Steels
Elite Extrusion Die Ltd.
EXCO – Brazil, Canada, Colombia,
Mexico, Texas, and USA
Gemini Group Extrusion Tooling
(GGET)
GIA Clecim Press
Idamex S.A.
MetALLsource, LLC

Phoenix International SpA
Qform Group
Southeastern Extrusion + Tool
Ultra-Sonic Extrusion Dies Inc.
WEFA Cedar Inc.
Youngstown Tool & Die Co. Inc.

DROSS TREATMENT/REMOVAL

ALTEK
ANDRITZ Metals USA Inc.
CETAG
EPIQ Machinery
Hertwich Engineering GmbH
Major Furnace Australia
Mechatherm International Ltd.
Presezzi Extrusion Group
Presezzi Extrusion North America
Pyrotek Inc.
Sanshin Industry, Ltd.
Scottish Chemical Industries
STAS Inc.
T.T. Tomorrow Technology S.p.A.
Wahl Refractory Solutions, LLC

FURNACES – BILLET HEATING

ANDRITZ Metals USA Inc.
Belco Industries, Inc.
Buelmann US LP
CitiUS Muhendislik
Chiz Bros
CNPT
COIM srl
Cometal Engineering SpA
Conticast Hormesa LLC
Danieli Breda
Ebner Furnaces, Inc.
Extral Technology
extrutec GmbH
extrutec N.A. Inc.
GIA Clecim Press
GHI Smart Furnaces
Gillespie & Powers
Granco Clark Inc.
HOWDEN Canada
IAS GmbH
International Thermal Systems
Otto Junker GmbH
Kautec Solutions
LOI Thermprocess GmbH
Major Furnace Australia
Marx GmbH & Co. KG
Marx LLC
OMAV S.p.A.
Presezzi Extrusion Group
Presezzi Extrusion North America
SECO/Warwick Corp.
Sistem Teknik Industrial Furnaces Ltd.
SMS group GmbH
SMS group, Inc.
Thorpe Technologies Inc.
Turla Extrusion Plants RFK S.R.L

FURNACES – HEAT TREATING

Almex USA Inc.
ANDRITZ Metals USA Inc.
Belco Industries Inc.



GRANCO CLARK®

100% Employee-owned

*Engineering. Manufacturing. Global Support.
Excellence is our standard.*

GRANCO CLARK, a global leader in the aluminum extrusion industry building a full range of aluminum extrusion equipment including some of the world's largest aluminum extrusion systems. GRANCO CLARK produces all required equipment to heat, cool, pull, stretch, cut, stack, age, and store aluminum extrusions. Leading in the optimization of extrusion technologies and processes, our automated equipment is designed, fully assembled and shop tested to the specific requirements of your extrusion process to deliver exceptional efficiency, productivity and longevity.

Contact us to discuss your next project.



Contact us to discuss your next project.

+1-800-918-2600 | www.grancoclark.com

We are 100% customer focused.



Directory of Aluminum Extrusion Equipment Manufacturers and Suppliers Categories/Companies

CitiUS Muhendislik
Chiz Bros
CNPT
COIM srl
Cometal Engineering SpA
Conticast Hormesa LLC
Danieli Breda
Ebner Furnaces, Inc.
EFR – John Cockerill
EPCON Industrial Furnaces
Extral Technology
extrutec GmbH
extrutec N.A. Inc.
Gautschi Engineering GmbH
Gerref Industries Inc.
Gillespie & Powers Inc.
GNA alutech inc.
Hertwich Engineering GmbH
HOWDEN Canada
IAS GmbH
International Thermal Systems
Otto Junker GmbH
LOI Thermprocess GmbH
Major Furnace Australia
Mechatherm International Ltd.
Novatec Innovative Systems
OMAV S.p.A.
Presezzi Extrusion Group
Presezzi Extrusion – Melting
Technology
Presezzi Extrusion North America
SECO/Warwick Corp.
Sistem Teknik Industrial Furnaces Ltd.
Surface Combustion, Inc.
Thermika Systems Inc.
Thorpe Technologies Inc.

FURNACE – MELTING/ HOLDING

Almex USA Inc.
ANDRITZ Metals USA Inc.
ATM Atilim Teknik Makine
CETAG
CitiUS Muhendislik
Chiz Bros
CNPT
COIM srl
Cometal Engineering SpA
Conticast Hormesa LLC
Danieli Breda
Dynamic Concept
EFR – John Cockerill
Fives North American Combustion
Gautschi Engineering GmbH
Gillespie & Powers Inc.
GNA alutech inc.
Hertwich Engineering GmbH
HOWDEN Canada
IAS GmbH
Inductotherm Corp.
Otto Junker GmbH
Major Furnace Australia
LOI Thermprocess GmbH
Marx GmbH & Co. KG
Marx LLC
Mechatherm International Ltd.

OMAV S.p.A.
Presezzi Extrusion Group
Presezzi Extrusion – Melting
Technology
Presezzi Extrusion North America
Scottish Chemical Industries
SECO/Warwick Corp.
Sistem Teknik Industrial Furnaces Ltd.
SMS group GmbH
SMS group, Inc.
Thorpe Technologies Inc.

GAS SUPPLIERS/SYSTEMS

Airgas, An Air Liquide Company
Air Products
ANDRITZ Metals USA Inc.
Fives North American Combustion
Messer Americas

GRAIN REFINING ROD DISPENSERS

Almex USA Inc.
CETAG
CitiUS Muhendislik
Hertwich Engineering GmbH
Hycast
Mechatherm International Ltd.
MQP Limited
Scottish Chemical Industries
Sistem Teknik Industrial Furnaces Ltd.
STAS

GRAPHITE MACHINE PARTS

Almex USA Inc.
GES-AGM USA
Graphite COVA GmbH
Mersen USA
Novelis PAE
Pyrotek, Inc.
Refractory Technology LLC
Scottish Chemical Industries
SGL Carbon GmbH
STAS

HYDRAULIC SYSTEMS (PRESSES)

Ajax/CECO/Erie Press
R.L. Best Company
Bosch Rexroth
Brilex Technical Solutions
Carco America
Cometal Engineering SpA
Danieli Breda
GIA Clecim Press
Macrodyne Press
The Oilgear Company
Presezzi Extrusion Group
Presezzi Extrusion North America
SMS group GmbH
SMS group, Inc.

HYDROGEN ANALYZERS

ABB Measurement & Analytics
Almex USA Inc.
Molten Metal Equipment Innovations
Scottish Chemical Industries

INCLUSION MEASUREMENT SYSTEMS

ABB Measurement & Analytics
Almex USA Inc.
MQP Limited

LASER MARKING/ TRACEABILITY

EPIQ Machinery
Granco Clark Inc.
Laserax
STAS

LUBRICANTS/LUBRICATION EQUIPMENT

Amcol Corporation
Moltultech Baraldi
Buelmann US LP
Castool Tooling Systems
Cometal Engineering SpA
Condat Lubricants
Foundry Service & Supplies, Inc.
Hubbard-Hall, Inc.
Interlub
ITW Pro Bands
Major Furnace Australia
Murlin Chemical Inc.
Northern Innovations
Pyrotek, Inc.
Quaker Houghton
Total Energies Marketing USA
ZYP Coatings, Inc.

MAINTENANCE

R.L. Best Company
Brilex Technical Solutions
Butech Bliss
Carco America
Carlesa NDE Services
Cometal Engineering SpA
Conticast Hormesa LLC
Daifuku America Corporation
Danieli Breda
DUNAWAY
Fives North American Combustion
Foshan ABD Equipment Co. Ltd.
Gillespie & Powers Inc.
Italtecno SRL
Lake Park Tool & Machine Inc.
LOI Thermprocess GmbH
Macrodyne Press
Marx LLC
SAT North America
Sistem Teknik Industrial Furnaces Ltd.
SMS group GmbH
SMS group, Inc.
Thorpe Technologies Inc.
Total Energies Marketing USA
Turla Extrusion Plants RFK S.R.L
UBE Machinery Inc.

MASTER ALLOYS/GRAIN REFINING

Almex USA Inc.
Excellent Foundry Fluxes Company
MQP Limited

been living under a rock?



In Phoenix, Arizona, a small manufacturing business is hard at work producing fully automated DieKlean machines for dozens of extruders all over the world.

**SHOULDN'T
YOU KNOW
ABOUT
THEM?**



**DIE CLEANING
EQUIPMENT**

Directory of Aluminum Extrusion Equipment Manufacturers and Suppliers Categories/Companies

Scottish Chemical Industries

MATERIAL HANDLING EQUIPMENT/VEHICLES

ALTEK
Behringer Saws, Inc.
Bradley Lifting Corp.
Butech Bliss
CitiUS Muhendislik
Combilift
Cometal Engineering SpA
emmebi srl
EPIQ Machinery
Friggi N.A. Inc.
Granco Clark Inc.
Irwin Car and Equipment
Presezzi Extrusion Group
Presezzi Extrusion North America
Sistem Teknik Industrial Furnaces Ltd.
T.T. Tomorrow Technology S.p.A.

METAL FILTERS/FILTRATION SYSTEMS

Conticast Hormesa LLC
Hycast
Mechatherm International Corp.
Novelis PAE
Presezzi Extrusion Group
Presezzi Extrusion North America
Pyrotek Inc.
STAS
Urja Products Pvt. Ltd.

METAL PUMPS

ABB Inc.
CitiUS Muhendislik
GES-AGM USA
Gillespie & Powers Inc.
Hertwich Engineering GmbH
Major Furnace Australia
Mechatherm International Ltd.
Molten Metal Equipment Innovations
Presezzi Extrusion Group
Presezzi Extrusion North America
Pyrotek Inc.
Thorpe Technologies Inc.
Zmag America, Ltd.

NITRIDING EQUIPMENT

ALMAX MORI
GIA Clecim Press
Nitrex Metal GmbH
Nitrex Metal Inc.
SECO/Warwick Corp.
Sistem Teknik Industrial Furnaces Ltd.
Surface Combustion, Inc.

NON-DESTRUCTIVE TESTING

Carlesa NDE Services
The L.S. Starrett Co.

PACKING LINES/PACKAGING

Belco Industries, Inc.
Bueltmann US LP
Cometal Engineering SpA
emmebi srl

EPIQ Machinery
Granco Clark Inc.
HOWDEN Canada
Kautec Solutions
N.T.K. Plants Management &
Business
Presezzi Extrusion Group
Presezzi Extrusion North America
SAT North America

PAINT & FINISHING SYSTEMS

Adwest Technologies, a CECO
Environmental Company
Belco Industries, Inc.
emmebi srl
Foshan ABD Equipment Co., Ltd.
Gerref Industries Inc.
GIA Clecim Press
Italtecno SRL
PPG Industries, Inc.
SAT North America

PLCs

Adwest Technologies, a CECO
Environmental Company
A.T.I.E. Uno Informatica
R.L. Best Company
Brilex Technical Solutions
Castool Tooling Systems
Cometal Engineering SpA
EPIQ Machinery
Fives North American Combustion
GIA Clecim Press
Gillespie & Powers
Italtecno SRL
LOI Thermprocess GmbH
Mechatherm International Ltd.
Presezzi Extrusion Group
Presezzi Extrusion North America
Sistem Teknik Industrial Furnaces Ltd.
SMS group GmbH
SMS group, Inc.
Thorpe Technologies Inc.
Turla Extrusion Plants RFK S.R.L.

POLLUTION CONTROL SYSTEMS

Adwest Technologies, a CECO
Environmental Company, Inc.
Anodizing Technologies Inc.
CECO Busch
Entecco Filter Technology USA
EPCON Industrial Systems
Fives North American Combustion
Italtecno SRL
Major Furnace Australia
Mechatherm International Ltd.
Nitrex Metal Inc.
Nitrex Metal Sp. z.o.o.
Sanshin Industry, Ltd.

PRESSES

Ajax/CECO/Erie Press
R.L. Best Company
Bosch Rexroth
Brilex Technical Solutions

Cometal Engineering SpA
Danieli Breda
DUNAWAY
Extral Technology
GIA Clecim Press
Greenerd Press & Machine Co.
Kautec Solutions
Macrodyne Press
N.T.K. Plants Management &
Business
OMAV S.p.A.
Presezzi Extrusion Group
Presezzi Extrusion North America
Siddharth Heavy Industries Pvt. Ltd.
SMS group GmbH
SMS group, Inc.
Turla Extrusion Plants RFK S.R.L
UBE Machinery Inc.

PRESS HANDLING SYSTEMS & MATERIALS

Albarrie Canada Limited
ALTEK
ANDRTIZ Metals USA Inc.
Belco Industries, Inc.
R.L. Best Company
B&O Saws
Bosch Rexroth
Bueltmann US LP
Butech Bliss
Cometal Engineering SpA
Daifuku America Corporation
Danieli Breda
DUNAWAY
Extral Technology
GIA Clecim Press
Granco Clark Inc.
Kautec Solutions
LOI Thermprocess GmbH
Macrodyne Press
OMAV S.p.A.
Presezzi Extrusion Group
Presezzi Extrusion North America
Siddharth Heavy Industries Pvt. Ltd.
Sistem Teknik Industrial Furnaces Ltd.
Tuff Temp Corp.
Turla Extrusion Plants RFK S.R.L.

PRESS LOADING EQUIPMENT

Belco Industries, Inc.
R.L. Best Company
Bosch Rexroth
Brilex Technical Solutions
Bueltmann US LP
Butech Bliss
Cometal Engineering SpA
Danieli Breda
DUNAWAY
Extral Technology
GIA Clecim Press
Kautec Solutions
Lake Park Tool & Machine Inc.
Macrodyne Press
The Oilgear Company
Presezzi Extrusion Group
Presezzi Extrusion North America



• **BOLSTER FURNACE**



• **HORIZONTAL SLIDING DOOR DIE OVEN**



• **FRONT LOADING DIE OVENS**



• **TOP LOADING DIE OVENS**

Infrared Tolling Ovens



• **MANDREL OVENS**



• **BOTTOM LOADING DIE OVENS**

NOVATEC

INNOVATIVE SOLUTIONS

Corporate Headquarters & Manufacturing Facilities:
Unit A - 19214 - 94th Avenue, Surrey, B.C. V4N 4E3 Canada
Tel: 604-888-3328 • Fax: 604-888-4538 • E-mail: sales@novatecpro.com
www.novatecpro.com

Directory of Aluminum Extrusion Equipment Manufacturers and Suppliers Categories/Companies

Siddharth Heavy Industries
Sistem Teknik Industrial Furnaces Ltd.
Turla Extrusion Plants RFK S.R.L

PRESS REVAMPS/ REPLACEMENT PARTS

R.L. Best Company
Bosch Rexroth
Brilex Technical Solutions
Butech Bliss
Carco America
Carlessa NDE Services
Castool Tooling Systems
Cometal Engineering SpA
Danieli Breda
DUNAWAY
Gemini Group Extrusion Tooling
(GGET)
GIA Clecim Press
Kautec Solutions
Lake Park Tool & Machine
Macrodyne Press
The Oilgear Company
Presezzi Extrusion Group
Presezzi Extrusion North America
Siddharth Heavy Industries Pvt. Ltd.
SMS group GmbH
SMS group, Inc.
Turla Extrusion Plants RFK S.R.L
UBE Machinery Inc.

PROCESS CONTROL & AUTOMATION SYSTEMS

ABB Inc.
Accurate Sensors Technologies Ltd.
Air Products
ANDRITZ Metals USA Inc.
Brilex Technical Solutions
Bueltmann US LP
Butech Bliss
Castool Tooling Systems
Cometal Engineering SpA
Conticast Hormesa LLC
Danieli Breda
emmebi srl
Fives North American Combustion
GAP Engineering SA
GIA Clecim Press
Hertwich Engineering GmbH
Hycast
Italteco SRL
Janus Automation LLC
Otto Junker GmbH
Kautec Solutions
Mechatherm International Ltd.
Nitrex Metal Inc.
Nitrex Metal Sp. z.o.o.
Novatec Innovative Systems
The Oilgear Company
Precimeter Control AB
Precimeter Inc.
Presezzi Extrusion Group
Presezzi Extrusion North America
Qform Group
Sistem Teknik Industrial Furnaces Ltd.
Wagstaff, Inc.

PROFILE FINISHING EQUIPMENT

Bueltmann US LP
Danieli Breda
emmebi srl
GIA Clecim Press
Presezzi Extrusion Group
Presezzi Extrusion North America
SAT North America

PUBLICATIONS (EXTRUSION)

Interall Srl
Kennedy Eurotech Inc.
Powder Coating Institute

PULLERS

Belco Industries, Inc.
R.L. Best Company
Cometal Engineering SpA
Danieli Breda
DUNAWAY
Extral Technology
GIA Clecim Press
Granco Clark Inc.
Kautec Solutions
OMAV S.p.A.
Presezzi Extrusion Group
Presezzi Extrusion North America
Siddharth Heavy Industries Pvt. Ltd.
SMS group GmbH
SMS group, Inc.
Turla Extrusion Plants RFK S.R.L

QUALITY CONTROL TEST EQUIPMENT

ABB Measurement & Analytics
Accurate Sensors Technologies Ltd.
Almex USA Inc.
Fives North American Combustion
iNOEX LLC
ISRA VISION Parsytec
The L.S. Starrett Co.
Taber Industries

QUENCHING SYSTEMS

Belco Industries, Inc.
Castool Tooling Systems
Cometal Engineering SpA
Conticast Hormesa LLC
Danieli Breda
Extral Technology
extrutech GmbH
extrutech N.A. Inc.
GIA Clecim Press
Granco Clark Inc.
Otto Junker GmbH
Kautec Solutions
LOI Thermprocess
OMAV S.p.A.
Presezzi Extrusion Group
Presezzi Extrusion North America
SECO/Warwick Corp.
Siddharth Heavy Industries
Sistem Teknik Industrial Furnaces Ltd.
Surface Combustion, Inc.
Turla Extrusion Plants RFK S.R.L

RACKS/STACKERS/ DESTACKERS

Belco Industries, Inc.
Bueltmann US LP
CitiUS Muhendislik
Cometal Engineering SpA
Danieli Breda
emmebi srl
Extral Technology
GIA Clecim Press
Granco Clark Inc.
HOWDEN Canada
Kautec Solutions
OMAV S.p.A.
Presezzi Extrusion Group
Presezzi Extrusion North America
Siddharth Heavy Industries
Turla Extrusion Plants RFK S.R.L

REFRACTORIES

Almex USA Inc.
Chiz Bros
COIM srl
Fives North American Combustion
Foundry Service and Supplies, Inc.
GES-AGM USA
Gillespie & Powers
Graphite COVA GmbH
Insulation Specialties of America
Mechatherm International Ltd.
Murlin Chemical Inc.
Plibrico Company, LLC
Pyrotek, Inc.
Refractory Technology LLC
Scottish Chemical Industries
Thorpe Technologies Inc.
Wahl Refractory Solutions, LLC

ROTARY EXTRUSION SYSTEMS

Siddharth Heavy Industries

RUNOUT ROLLERS

Albarrie Canada Limited
Belco Industries Inc.
R.L. Best Company
Butech Bliss
Cometal Engineering SpA
Danieli Breda
Ecofill USA
Extral Technology
Granco Clark, Inc.
Ichikawa North America
Northern Innovations
OMAV S.p.A.
Presezzi Extrusion Group
Presezzi Extrusion North America
Siddharth Heavy Industries
Tuff Temp Corp.
Turla Extrusion Plants RFK S.R.L

SAWS/ SAW CONSUMABLES

Behringer Saws, Inc.
Belco Industries, Inc.
R.L. Best Company
B&O Saws
Bueltmann US LP

GROUP

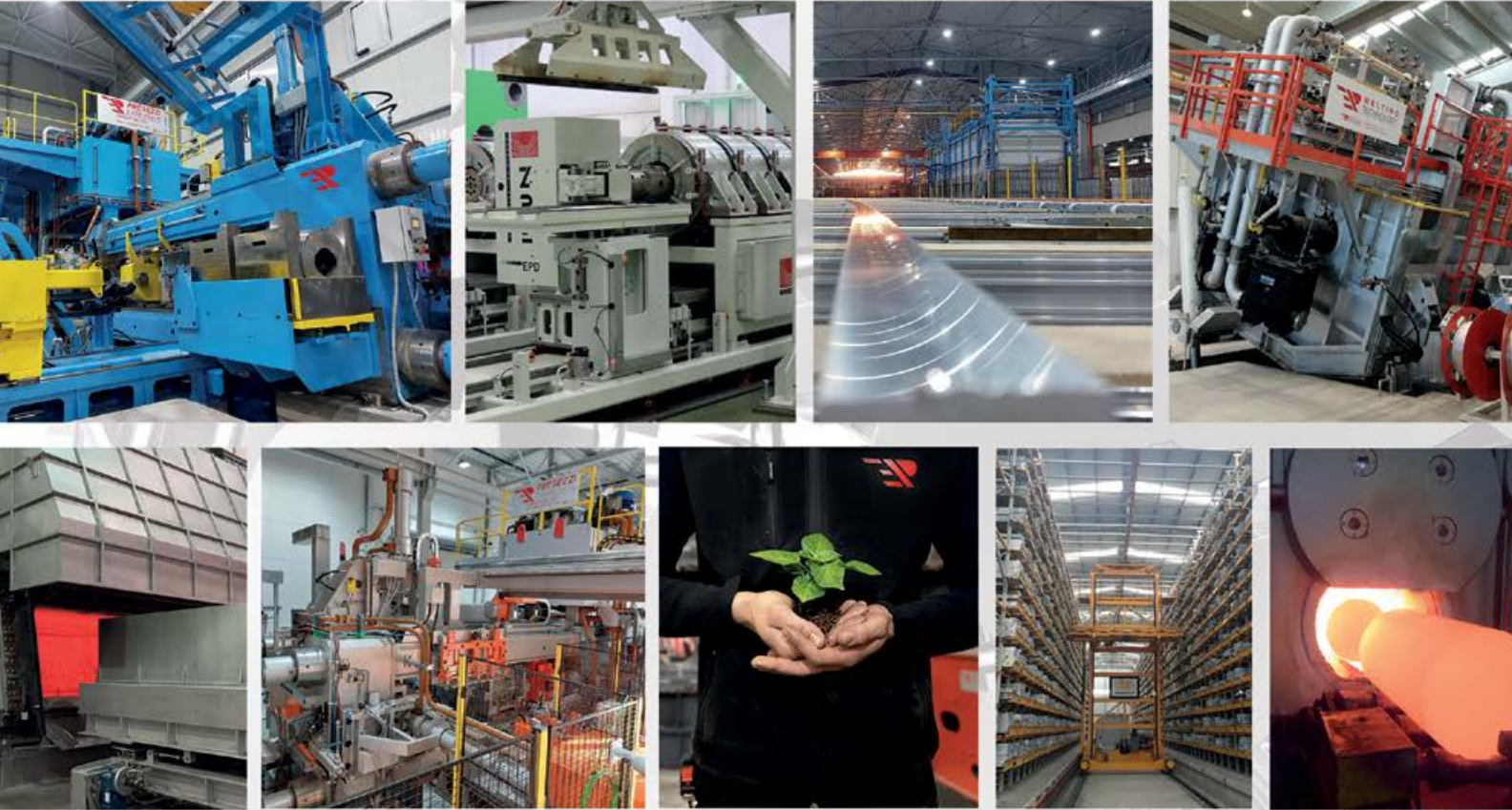

We drive the extrusion and recycling world
to a more **sustainable future**

PREZEZZI EXTRUSION GROUP

Fully Integrated System for Aluminium, Copper and Brass industries



Extrusion Lines



Packaging & Storage



Gas Billet Heaters



Melting Equipment

PREZEZZI EXTRUSION S.p.A. - 20871 Vimercate (MB) - Via Rovereto, 1/d - ITALY Tel +39 039 635011 - info@prezezziextrusion.com
NORTH AMERICA - Bruno Donada - Tel: +1 847 676 2459 - Fax: +1 847 676 2459 - b.donada@prezezziextrusion.com

www.prezezziextrusiongroup.com

Directory of Aluminum Extrusion Equipment Manufacturers and Suppliers Categories/Companies

CitiUS Muhendislik
Cometal Engineering SpA
Danieli Breda
EPIQ Machinery
Extral Technology
extrutec GmbH
extrutec N.A. Inc.
Friggi N.A. Inc.
GIA Clecim Press
Granco Clark Inc.
Hertwich Engineering GmbH
HPI GmbH
Otto Junker GmbH
Kautec Solutions
Mechatherm International Ltd.
August Mössner GmbH
OMAV S.p.A.
Presezzi Extrusion Group
Presezzi Extrusion North America
Sermas
Siddharth Heavy Industries Pvt. Ltd.
Sistem Teknik Industrial Furnaces Ltd.
SMS group GmbH
SMS group, Inc.
Starcut SRL
The L.S. Starrett Co.

SHEARS

Belco Industries, Inc.
R.L. Best Company
Butech Bliss
Castool Tooling Systems
Danieli Breda
DUNAWAY
emmebi srl
Extral Technology
GIA Clecim Press
Granco Clark Inc.
Kautec Solutions
Lake Park Tool & Machine
OMAV S.p.A.
Presezzi Extrusion Group
Presezzi Extrusion North America
Siddharth Heavy Industries Pvt. Ltd.
Sistem Teknik Industrial Furnaces Ltd.
SMS group GmbH
SMS group, Inc.
Turla Extrusion Plants RFK S.R.L.

STIRRERS

ABB Inc.
ALTEK
CitiUS Muhendislik
Cometal Engineering SpA
Conticast Hormesa LLC
Fives North American Combustion
GES-AGM USA
Hertwich Engineering GmbH
LOI Thermprocess GmbH
Mechatherm International Ltd.
Presezzi Extrusion Group
Presezzi Extrusion North America
Pyrotek Inc.
Sistem Teknik Industrial Furnaces Ltd.
Zmag America, Ltd.

STRETCHERS/ STRAIGHTENERS

Ajax/CECO/Erie Press
Belco Industries, Inc.
R.L. Best Company
Buelmann US LP
Butech Bliss
Cometal Engineering SpA
Danieli Breda
DUNAWAY
Extral Technology
GIA Clecim Press
Granco Clark Inc.
Kautec Solutions
OMAV S.p.A.
Presezzi Extrusion Group
Presezzi Extrusion North America
Siddharth Heavy Industries Pvt. Ltd.
SMS group GmbH
SMS group, Inc.
Turla Extrusion Plants RFK S.R.L.

TABLE COOLERS/FANS

Belco Industries, Inc.
R.L. Best Company
Cometal Engineering SpA
Danieli Breda
GIA Clecim Press
Kautec Solutions
OMAV S.P.A.
Presezzi Extrusion Group
Presezzi Extrusion North America
Turla Extrusion Plants RFK S.R.L.

TEMPERATURE MEASUREMENT SYSTEMS

Accurate Sensors Technologies Ltd.
Almex USA Inc.
AMETEK Land
Anritsu Meter Co.
Castool Tooling Systems
N.T.K. Plants Management & Business
Presezzi Extrusion Group
Presezzi Extrusion North America
Pyrotek Inc.
Williamson Corp.

THERMAL BREAK EQUIPMENT

AZON
Presezzi Extrusion Group
Presezzi Extrusion North America

TOOL HANDLING EQUIPMENT

Castool Tooling Systems
EPIQ Machinery
Presezzi Extrusion Group
Presezzi Extrusion North America
SMS group GmbH
SMS group, Inc.

TOOL STEELS

BOHLER
Castool Tooling Systems
EDRO Specialty Steels
Gemini Group Extrusion Tooling

(GGET)
Kind & Co. Edelstahlwerk, KG
Lake Park Tool & Machine Inc.
MetALLsource, LLC
Southeastern Extrusion & Tool, Inc.
Starcut SRL
Uddeholm USA

TOOLING

ALMAX MORI
R.L. Best Company
BOHLER
Castool Tooling Systems
Compes International
Compes S.P.A.
Danieli Breda
DUNAWAY
EDRO Specialty Steels
EXCO – Brazil, Canada, Colombia,
Mexico, Texas, and USA
GAP Engineering SA
Gemini Group Extrusion Tooling
(GGET)
GIA Clecim Press
Idamex S.A.
Kind & Co. Edelstahlwerk, KG
Lake Park Tool & Machine Inc.
MetALLsource, LLC
Phoenix International SpA
Siddharth Heavy Industries Pvt. Ltd.
SMS group GmbH
SMS group, Inc.
Southeastern Extrusion & Tool
Starcut SRL
Ultra-Sonic Extrusion Dies Inc.

EQUIPMENT AGENTS / USED EQUIPMENT (PRIMARY BUSINESS)

Aluminum Casting Technologies, LLC
Aluminum Extrusion Marketplace
ExtrusionSupplies
Machinery International Corp.
National Machinery Exchange
Phipps Company
RFTS LLC

List Your Company in Our Next Directory

To find out how to get your company listed in the next Directory of Aluminum Extrusion Equipment Manufacturers & Suppliers, email *Light Metal Age* at Ima@lightmetalage.com, fax us at 650-588-0901, or call 650-588-8832 with your name and company contact information.

To learn more, visit us at:
www.lightmetalage.com

WE'RE THE EXTRUSION MACHINERY SPECIALISTS!

- **New Container Assemblies and Relines**
- **New and Rebuilt Cylinders**
- **Press Rebuilding and Installation**
- **Tie Rods, Stems, Dummy blocks**
- **Handling Equipment**
- **Complete Field Service**
- **Emergency Breakdown Service**
- **Extrusion Supplies and Consulting**
- **Press Maintenance and Inspection**



WE CAN HELP WITH ALL YOUR EXTRUSION RELATED NEEDS!

For over 40 years, Dunaway has been a locally owned and operated company located in Canfield, OH. We have over 100 years of combined experience in the designing, building and upgrading of extrusion presses and systems. These turnkey capabilities allow us to support our customers with any job size, from relining containers to major system installations.

Our in house CNC machining capabilities allow us to machine to tolerances of .0005", providing the finest quality extrusion press components. Additional services include engineering, manufacturing, installing and field service for conversions, rebuilds and complete systems. Dunaway components and systems are installed worldwide – from the U.S. and Canada, to Europe and Asia-Pacific. Call us to see how we can help you. We're the Extrusion Specialists!



New 500 Ton Extrusion Press



New 1800 Ton Billet Loader

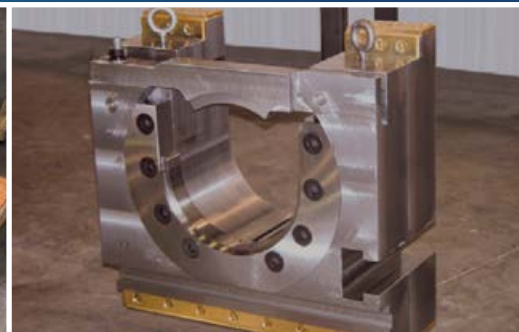

New Die Shuffle



DUNAWAY
EXTRUSION MACHINERY SPECIALISTS

5959 Leffingwell Road
Canfield, Ohio 44406

☎ 330-533-7753

✉ sales@dunawayinc.com

www.dunawayinc.com

Index to Directory of Secondary Aluminum* Equipment Manufacturers & Suppliers

| | | | |
|---|----|---|----|
| Alloying Elements | 26 | Laser Marking/Traceability | 30 |
| Automation/Control Systems | 26 | Launders, Troughs, Crucibles | 30 |
| Balers/Compactors | 26 | Lubrication/Coatings | 32 |
| Briquetting | 26 | Material Handling Equipment/Vehicles | 32 |
| Caster Tips | 26 | Metal Measurement/Testing | 32 |
| Casting Equipment - Billet/Slab/Ingot/Strip | 26 | Molds | 32 |
| Chip Handling | 26 | Molten Level Control | 32 |
| Chip Melters | 28 | Molten Metal Analysis | 32 |
| Combustion Equipment (Burners) | 28 | Molten Metal Filtration | 32 |
| Consulting Engineers (Primary Business) | 28 | Molten Metal Pumps | 32 |
| Conveyors | 28 | Molten Metal Transfer Trucks | 32 |
| Degassing | 28 | Pollution Control Equipment | 32 |
| Delacquering/Decoating Equipment | 28 | Quality Control | 32 |
| Dross Cooling Equipment | 28 | Refractory Supply/Maintenance | 32 |
| Dross Handling Equipment | 28 | Rotary Gas/Flux Injectors | 32 |
| Flux/Fluxing | 28 | Rotary Kilns/Dryers | 33 |
| Furnace Charging Machines | 28 | Sawing Systems/Equipment | 33 |
| Furnace Tending Machines | 28 | Scrap Submergence Systems | 33 |
| Furnaces – Homogenizing | 28 | Shredders | 33 |
| Furnaces – Melting/Holding | 30 | Sorting & Separation Systems | 33 |
| Furnaces – Preheat | 30 | Sow Casting/Handling Equipment | 33 |
| Furnaces – Rotary | 30 | Stirring/Vortexing Equipment | 33 |
| Grain Refining | 30 | Strapping/Packaging | 33 |
| Hydraulic Drive Systems | 30 | Temperature Measurement/Control Equipment | 33 |
| Hydrogen Analyzers | 30 | Ultrasonic Testing | 33 |
| Inclusion Measurement | 30 | Used Equipment (Primary Business) | 33 |
| Industrial Gases | 30 | Vibratory Feeders | 33 |
| Ingot Stacking/Handling Equipment | 30 | Weighing Equipment | 33 |
| Ladle Equipment | 30 | | |

*Secondary aluminum producers are defined as secondary smelters and remelters of aluminum. Secondary smelters process different types of scrap, while remelters process billet or pure scrap of one or more alloy.

Directory of Secondary Aluminum Equipment Manufacturers & Suppliers Categories/Companies

| | | |
|--|---|--|
| <p>ALLOYING ELEMENTS</p> <p>Almex USA Inc. Excellent Foundry Fluxes Company Scottish Chemical Industries Sistem Teknik Industrial Furnaces</p> | <p>Quickdraft Sistem Teknik Industrial Furnaces Surface Combustion, Inc. Thorpe Technologies Inc. Wagstaff, Inc.</p> | <p>CASTING EQUIPMENT – BILLET/ SLAB/ INGOT/ STRIP</p> <p>Almex USA Inc. ALTEK ATM Atilim Teknik Makine CASTAL Engineering CitiUS Muhendislik Conticast Hormesa LLC Continuus Properzi S.P.A. Dynamic Concept Gautschi Engineering GmbH GHI Smart Furnaces Gillespie & Powers Hertwich Engineering HPI GmbH Hycast LOI Thermprocess GmbH Mansell and Associates Mechatherm International Ltd. Novelis PAE Properzi International, Inc. Scottish Chemical Industries Sistem Teknik Industrial Furnaces Southwire SCR Technologies Thorpe Technologies Inc. Wagstaff, Inc.</p> |
| <p>AUTOMATION/ CONTROL SYSTEMS</p> <p>ABB Inc. Accurate Sensors Technologies Ltd. Almex USA Inc. ANDRITZ Metals USA Inc. Can-Eng Furnaces International CitiUS Muhendislik Continuus-Properzi SpA Dynamic Concept EBNER Furnaces, Inc. EPIQ Machinery Gillespie & Powers, Inc. Hatch Hertwich Engineering GmbH HOWDEN Canada Hycast Innovatherm Janus Automation LLC LOI Thermprocess GmbH Mechatherm International Ltd. August Mössner GmbH & Co. KG Novelis PAE Precimeter Control AB Precimeter Inc.</p> | <p>BALERS/ COMPACTORS</p> <p>ATM Atilim Teknik Makine Gillespie & Powers Granutech – Saturn Systems Quickdraft Thorpe Technologies Inc. Wendt Corporation</p> <p>BRIQUETTING</p> <p>ATM Atilim Teknik Makine Conticast Hormesa LLC Friggi America Gillespie & Powers Hertwich Engineering Quickdraft Thorpe Technologies Inc.</p> <p>CASTER TIPS</p> <p>Conticast Hormesa LLC Foundry Service and Supplies, Inc. Insulation Specialties of America Pyrotek Refractory Technology LLC ZIRCAR Ceramics, Inc.</p> | <p>CHIP HANDLING</p> <p>B&O Saws Conticast Hormesa LLC EPIQ Machinery</p> |

SECO/WARWICK



VORTEX[®]

JET HEATING

Efficient aluminum coil annealing

- Get unparalleled temperature uniformity with patented Vortex[®] nozzle technology
- Reduce the overall cycle time of your furnaces up to 30% with proprietary jet flow technology
 - Eliminate local overheating
- Minimize costs and utilities consumption

Learn more about how to improve your heat treating efficiency and productivity at:

SECOWARWICK.com

Directory of Secondary Aluminum Equipment Manufacturers & Suppliers Categories/Companies

Eriez
Friggi America
Gillespie & Powers
Hertwich Engineering
HOWDEN Canada
Mechatherm International Ltd.
August Mössner GmbH & Co. KG
Pyrotek
Quickdraft
Sistem Teknik Industrial Furnaces
Thorpe Technologies Inc.

CHIP MELTERS

ANDRITZ Metals USA Inc.
CitiUS Muhendislik
Conticast Hormesa LLC
Fives North American Combustion
GHI Smart Furnaces
Gillespie & Powers, Inc.
GNA alutech inc.
Hertwich Engineering
HOWDEN Canada
Inductotherm Corp.
Otto Junker GmbH
Mansell and Associates, Ltd.
Molten Metal Equipment Innovations
Pyrotek
Sistem Teknik Industrial Furnaces
Thorpe Technologies Inc.
Zmag America, Ltd.

COMBUSTION EQUIPMENT (BURNERS)

Airgas, an Air Liquide Company
Air Products
ATM Atilim Teknik Makine
Bloom Engineering
CETAG
CitiUS Muhendislik
EBNER Furnaces, Inc. , Inc.
EPCON Industrial Systems
Fives North American Combustion
Gillespie & Powers, Inc.
HCT, part of Bloom Engineering
Innovatherm
LINDE
Major Furnace Australia Pty. Ltd.
Mechatherm International Ltd.
Messer Americas
Sistem Teknik Industrial Furnaces
Southwire SCR Technologies
Surface Combustion, Inc.
Thorpe Technologies Inc.

CONSULTING ENGINEERS (PRIMARY BUSINESS)

Hatch
Oculatus Consulting
Ramboll
RFTS LLC

CONVEYORS

ATM Atilim Teknik Makine
CitiUS Muhendislik
EPIQ Machinery
Eriez

Gillespie & Powers
GLAMA Maschinenbau GmbH
Mansell and Associates
August Mössner GmbH & Co. KG
Quickdraft
Sistem Teknik Industrial Furnaces
Thorpe Technologies Inc.

DEGASSING

Airgas, an Air Liquide Company
Almex USA Inc.
ATM Atilim Teknik Makine
CitiUS Muhendislik
Conticast Hormesa LLC
Continuus Properzi S.P.A.
Excellent Foundry Fluxes Company
Gautschi Engineering GmbH
GES-AGM USA
Graphite Cova GmbH
Hertwich Engineering GmbH
LINDE
Mechatherm International Ltd.
Mersen USA GS Corp - Greenvile
Molten Metal Equipment Innovations
Novelis PAE
Properzi International, Inc.
Pyrotek
Scottish Chemical Industries
SGL Carbon GmbH
Sistem Teknik Industrial Furnaces
Southwire SCR Technologies
STAS
Termia Technology Corporation

DELACQUERING/ DECOATING EQUIPMENT

CitiUS Muhendislik
Fives North American Combustion
GHI Smart Furnaces
Gillespie & Powers, Inc.
Otto Junker GmbH
Major Furnace Australia Pty. Ltd.
Mechatherm International Ltd.
Sistem Teknik Industrial Furnaces
Thorpe Technologies Inc.

DROSS COOLING EQUIPMENT

ALTEK
CETAG
Conticast Hormesa LLC
GHI Smart Furnaces
Hertwich Engineering
Insulation Specialties of America
LINDE
Sanshin Industry
STAS

DROSS HANDLING EQUIPMENT

ALTEK
CETAG
CitiUS Muhendislik
Conticast Hormesa LLC
EPIQ Machinery
Mechatherm International Ltd.

Pyrotek
RIA Cast House Engineering
Sanshin Industry
T.T. Tomorrow Technology
Wahl Refractory Solutions, LLC

FLUX/ FLUXING

Additive Solutions Ltd.
ATM Atilim Teknik Makine
Graphite Cova GmbH
Molten Metal Equipment Innovations
Pyrotek
Scottish Chemical Industries
STAS

FURNACE CHARGING MACHINES

ATM Atilim Teknik Makine
CETAG
CitiUS Muhendislik
Conticast Hormesa LLC
Continuus-Properzi SpA
EBNER Furnaces, Inc.
EPIQ Machinery
GHI Smart Furnaces
Gillespie & Powers
GLAMA Maschinenbau GmbH
GNA alutech inc.
Hencon B.V.
Hertwich Engineering
HOWDEN Canada
HPI GmbH
Inductotherm Corp.
International Thermal Systems
Major Furnace Australia Pty. Ltd.
Mansell and Associates
Mechatherm International Ltd.
Prezezzi Extrusion – Melting Tech.
RIA Cast House Engineering
Sistem Teknik Industrial Furnaces
Surface Combustion, Inc.
Techmo Car S.p.A.
Thorpe Technologies Inc.
T.T. Tomorrow Technology

FURNACE TENDING MACHINES

CitiUS Muhendislik
Conticast Hormesa LLC
EPIQ Machinery
GHI Smart Furnaces
GLAMA Maschinenbau GmbH
Hencon B.V.
Mechatherm International Ltd.
RIA Cast House Engineering
Techmo Car S.p.A.
T.T. Tomorrow Technology

FURNACES – HOMOGENIZING

Almex USA Inc.
ANDRITZ Metals USA Inc.
ATM Atilim Teknik Makine
Can-Eng Furnaces International
Chiz Bros.
CitiUS Muhendislik
Conticast Hormesa LLC
EBNER Furnaces, Inc.



Advanced solutions for aluminum

Providing high efficiency, industry tested, eco-friendly melting solutions for aluminum and other light metal alloys—Inductotherm designs, customizes, and manufactures aluminum melting furnaces for foundry, recycling, diecasting, chip melting, and investment casting. We offer a complete range of remelting and alloying steel shell furnaces; air-cooled direct-electric heat Acutrak® systems; free-standing Lift-Swing furnaces, and large-capacity Hybrid™ furnaces for billet/slab casting operations, and more. Find out which furnace is best suited for your melting application by contacting our experts at sales@inductotherm.com.

*Inductotherm Corp. • 10 Indel Avenue, PO Box 157 • Rancocas, NJ 08073-0157
1.888.INDUCTO • sales@inductotherm.com • www.inductotherm.com*

Directory of Secondary Aluminum Equipment Manufacturers & Suppliers Categories/Companies

EFR - John Cockerill
 EPCON Industrial Systems
 Fives North American Combustion
 Gautschi Engineering GmbH
 GHI Smart Furnaces
 Gillespie & Powers
 GNA alutech inc.
 Hertwich Engineering
 HOWDEN Canada
 HPI GmbH
 International Thermal Systems
 Otto Junker GmbH
 LOI Thermprocess GmbH
 Major Furnace Australia Pty. Ltd.
 Mechatherm International Ltd.
 Presezzi Extrusion – Melting Tech.
 SECO/Warwick Corp.
 Sistem Teknik Industrial Furnaces
 Surface Combustion, Inc.
 Thorpe Technologies Inc.

FURNACES – MELTING/ HOLDING

Almex USA Inc.
 ANDRITZ Metals USA Inc.
 ATM Atilim Teknik Makine
 CASTAL Engineering
 CETAG
 Chiz Bros.
 CitiUS Muhendislik
 Conticast Hormesa LLC
 Continuus Properzi S.P.A.
 Dynamic Concept
 EFR - John Cockerill
 Fives North American Combustion
 Gautschi Engineering GmbH
 GHI Smart Furnaces
 Gillespie & Powers, Inc.
 GNA alutech inc.
 Hertwich Engineering
 HOWDEN Canada
 Inductotherm Corp.
 Otto Junker GmbH
 LINDE
 LOI Thermprocess GmbH
 Major Furnace Australia Pty. Ltd.
 Mansell and Associates
 Mechatherm International Ltd.
 Presezzi Extrusion – Melting Tech.
 Properzi International, Inc.
 SECO/Warwick Corp.
 Sistem Teknik Industrial Furnaces
 Southwire SCR Technologies
 Termia Technology Corporation
 Thorpe Technologies Inc.

FURNACES – PREHEAT

ANDRITZ Metals USA Inc.
 Chiz Bros.
 CitiUS Muhendislik
 Conticast Hormesa LLC
 Dynamic Concept
 EBNER Furnaces, Inc.
 EFR - John Cockerill
 EPCON Industrial Systems
 Fives North American Combustion

GHI Smart Furnaces
 Gillespie & Powers, Inc.
 GNA alutech inc.
 Hertwich Engineering
 HOWDEN Canada
 Inductotherm
 International Thermal Systems
 Otto Junker GmbH
 LOI Thermprocess GmbH
 Major Furnace Australia Pty. Ltd.
 Mansell and Associates
 Mechatherm International Ltd.
 Presezzi Extrusion – Melting Tech.
 SECO/Warwick Corp.
 Sistem Teknik Industrial Furnaces
 STAS
 Thorpe Technologies Inc.

FURNACES – ROTARY

ALTEK, LLC
 ANDRITZ Metals USA Inc.
 ATM Atilim Teknik Makine
 Can-Eng Furnaces International
 Chiz Bros.
 CitiUS Muhendislik
 Conticast Hormesa LLC
 Fives North American Combustion
 GHI Smart Furnaces
 Gillespie & Powers, Inc.
 GNA alutech inc.
 Hertwich Engineering
 International Thermal Systems
 LOI Thermprocess GmbH
 Major Furnace Australia Pty. Ltd.
 Mansell and Associates
 Mechatherm International Ltd.
 SECO/Warwick Corp.
 Sistem Teknik Industrial Furnaces
 Surface Combustion, Inc.
 Thorpe Technologies Inc.

GRAIN REFINING

Almex USA Inc.
 CETAG
 CitiUS Muhendislik
 Excellent Foundry Fluxes Company
 Hertwich Engineering
 Hycast
 Mechatherm International Ltd.
 MQP
 Pyrotek
 Scottish Chemical Industries
 STAS

HYDRAULIC DRIVE SYSTEMS

Bosch Rexroth

HYDROGEN ANALYZERS

ABB Measurement & Analytics
 Almex USA Inc.
 Molten Metal Equipment Innovations

INCLUSION MEASUREMENT

ABB Measurement & Analytics
 Almex USA Inc.

INDUSTRIAL GASES

Airgas, an Air Liquide Company
 Air Products
 Almex USA Inc.
 LINDE
 Messer Americas

INGOT STACKING/ HANDLING EQUIPMENT

ATM Atilim Teknik Makine
 B&O Saws
 Bradley Lifting Corp.
 CitiUS Muhendislik
 Conticast Hormesa LLC
 EBNER Furnaces, Inc.
 EPIQ Machinery
 Hertwich Engineering
 HOWDEN Canada
 HPI GmbH
 Mansell and Associates
 August Mössner GmbH & Co. KG
 Properzi International, Inc.
 Sermas Industries
 Sistem Teknik Industrial Furnaces
 STAS

LADLE EQUIPMENT

ATM Atilim Teknik Makine
 EPIQ Machinery
 Fives North American Combustion
 GHI Smart Furnaces
 Gillespie & Powers, Inc.
 GLAMA Maschinenbau GmbH
 Hencon B.V.
 Mansell and Associates
 Pyrotek
 STAS
 Techmo Car S.p.A.
 Termia Technology Corporation
 Thorpe Technologies Inc.
 Wahl Refractory Solutions, LLC

LASER MARKING/ TRACEABILITY

EPIQ Machinery
 InfoSight Corporation
 Laserax
 Sistem Teknik Industrial Furnaces
 STAS

LAUNDERS, TROUGHS, CRUCIBLES

Almex USA Inc.
 ANDRITZ Metals USA Inc.
 ATM Atilim Teknik Makine
 CETAG
 CitiUS Muhendislik
 Conticast Hormesa LLC
 Dynamic Concept
 Fives North American Combustion
 Foundry Service and Supplies, Inc.
 Gautschi Engineering GmbH
 GES-AGM USA
 Gillespie & Powers, Inc.
 GNA alutech inc.
 Hycast

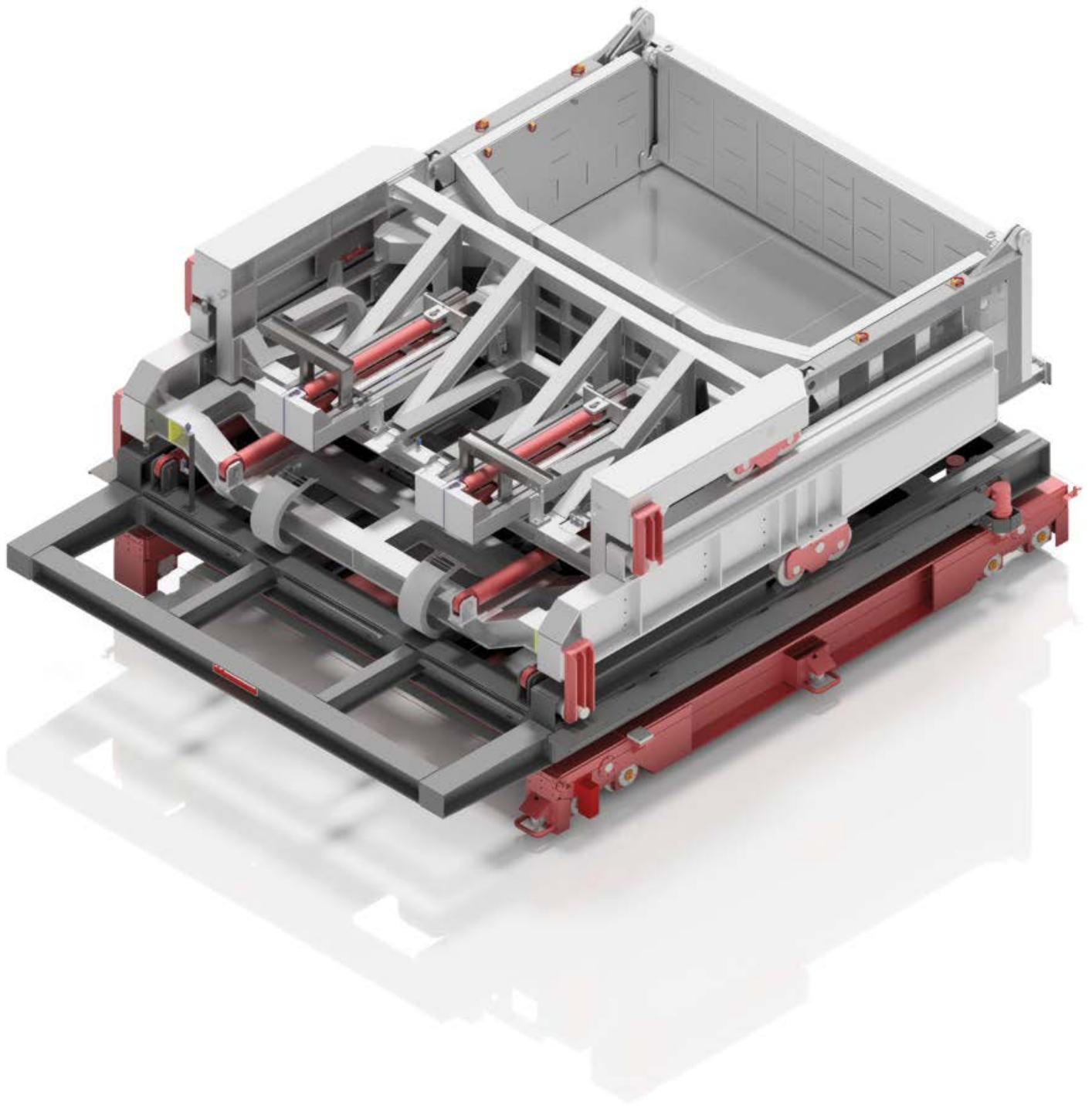

Significantly reducing charging times, whilst improving operator safety. Our fully automated X-Series scrap charging machines are now available with interchangeable charge boxes to streamline the charge process times, reduce cycle times and increase throughput.

Mechatherm
aluminium casthouse solutions

www.mechatherm.com | +44 1384 279 132 | sales@mechatherm.co.uk

Directory of Secondary Aluminum Equipment Manufacturers & Suppliers Categories/Companies

Insulation Specialties of America
Major Furnace Australia Pty. Ltd.
Mansell and Associates
Mechatherm International Ltd.
Pyrotek
Refractory Technology LLC
Scottish Chemical Industries
Sistem Teknik Industrial Furnaces
Southwire SCR Technologies
STAS
Termia Technology Corporation
Thorpe Technologies Inc.
Wagstaff, Inc.
Wahl Refractory Solutions, LLC
ZIRCAR Ceramics, Inc.

LUBRICATION/ COATINGS

Almex USA Inc.
Amcol Corporation
Condat Lubricants
Foundry Service & Supplies, Inc.
ITW Pro Brands
Pyrotek
Quaker Houghton
Scottish Chemical Industries
TotalEnergies Marketing USA
ZIRCAR Ceramics, Inc.

MATERIAL HANDLING EQUIPMENT/ VEHICLES

Behringer Saws
Combilift
EPIQ Machinery
Eriez
Friggi America
GLAMA Maschinenbau GmbH
Hencon B.V.
HPI GmbH
Quickdraft
RIA Cast House Engineering GmbH
Sermas Industries
Sistem Teknik Industrial Furnaces
STAS
Surface Combustion, Inc.
Techmo Car S.p.A.
T.T. Tomorrow Technology

METAL MEASUREMENT/ TESTING

ABB Measurement & Analytics
Almex USA Inc.
Conticast Hormesa LLC
Hycast
Rigaku Analytical Devices
STAS
Wagstaff, Inc.

MOLDS

Almex USA Inc.
ALTEK
ATM Atilim Teknik Makine
Conticast Hormesa LLC
Dynamic Concept
EPIQ Machinery
Gautschi Engineering GmbH
GES-AGM USA

Hertwich Engineering
Hycast
Mersen USA GS Corp - Greenville
Novelis PAE
Pyrotek
SGL Carbon GmbH - Graphite
Solutions
STAS
Wagstaff, Inc.

MOLTEN LEVEL CONTROL

Almex USA Inc.
ANDRITZ Metals USA Inc.
Dynamic Concept
Gillespie & Powers, Inc.
Hycast
Janus Automation LLC
Mechatherm International Ltd.
Molten Metal Equipment Innovations
Novelis PAE
Precimeter Control AB
Precimeter Inc.
Thorpe Technologies Inc.
Wagstaff, Inc.

MOLTEN METAL ANALYSIS

ABB Measurement & Analytics
Almex USA Inc.
ALTEK, LLC
Conticast Hormesa LLC
STAS

MOLTEN METAL FILTRATION

Almex USA Inc.
ANDRITZ Metals USA Inc.
CitiUS Muhendislik
Conticast Hormesa LLC
Hycast
Mechatherm International Ltd.
Molten Metal Equipment Innovations
Novelis PAE
Pyrotek
Scottish Chemical Industries
Sistem Teknik Industrial Furnaces
STAS
Urja Products Pvt. Ltd.

MOLTEN METAL PUMPS

CitiUS Muhendislik
Conticast Hormesa LLC
Fives North American Combustion
GES-AGM USA
Gillespie & Powers, Inc.
Graphite Cova GmbH
Hertwich Engineering
Mechatherm International Ltd.
Molten Metal Equipment Innovations
Precimeter Control AB
Pyrotek
SGL Carbon GmbH - Graphite
Solutions
Sistem Teknik Industrial Furnaces
Thorpe Technologies Inc.
Zmag America, Ltd.

MOLTEN METAL TRANSFER TRUCKS

Conticast Hormesa LLC
EPIQ Machinery
GLAMA Maschinenbau GmbH
STAS
Techmo Car S.p.A.

POLLUTION CONTROL EQUIPMENT

Adwest Technologies Inc., a CECO
Environmental Company
AMETEK Land
ANDRITZ Metals USA Inc.
ATM Atilim Teknik Makine
CECO Busch
Entecco Filter Technology USA
EPCON Industrial Systems
Gillespie & Powers, Inc.
Innovatherm
Major Furnace Australia Pty. Ltd.
Mansell and Associates
O2 Environmental Technologies Inc.
Thorpe Technologies Inc.
Wendt Corporation

QUALITY CONTROL

ABB Measurement & Analytics
Almex USA Inc.
ALTEK
Conticast Hormesa LLC
IMS Systems, Inc.
REDWAVE
Rigaku Analytical Devices

REFRACTORY SUPPLY/ MAINTENANCE

Almex USA Inc.
ANDRITZ Metals USA Inc.
Chiz Bros.
Fives North American Combustion
Foundry Services and Supplies, Inc.
GES-AGM USA
Gillespie & Powers, Inc.
Graphite Cova GmbH
Insulation Specialties of America
Major Furnace Australia Pty. Ltd.
Mechatherm International Ltd.
Murlin Chemical Inc.
Plibrico Company, LLC
Pyrotek
Refractory Technology LLC
Scottish Chemical Industries
Thorpe Technologies Inc.
Wahl Refractory Solutions
ZIRCAR Ceramics, Inc.

ROTARY GAS/ FLUX INJECTORS

Almex USA Inc.
Excellent Foundry Fluxes Company
GES-AGM USA
Graphite Cova GmbH
LINDE
Mersen USA GS Corp - Greenville
Molten Metal Equipment Innovations

Directory of Secondary Aluminum Equipment Manufacturers & Suppliers Categories/Companies

Pyrotek
SGL Carbon GmbH - Graphite
Solutions
STAS

ROTARY KILNS/ DRYERS

Chiz Bros.
Conticast Hormesa LLC
GHI Smart Furnaces
Gillespie & Powers, Inc.
HOWDEN Canada
Major Furnace Australia Pty. Ltd.
Sistem Teknik Industrial Furnaces
Thorpe Technologies Inc.

SAWING SYSTEMS/ EQUIPMENT

B&O Saws
Behringer Saws, Inc.
CitiUS Muhendislik
Conticast Hormesa LLC
EPIQ Machinery
Friggi America
Hertwich Engineering
HPI GmbH
August Mössner GmbH + Co. KG
Sermas Industrie
Sistem Teknik Industrial Furnaces
The L.S. Starrett Co.
STAS

SCRAP SUBMERGENCE SYSTEMS

Fives North American Combustion
Gillespie & Powers, Inc.
Hertwich Engineering
Molten Metal Equipment Innovations
Pyrotek
Techmo Car S.p.A.
Thorpe Technologies Inc.
Wahl Refractory Solutions, LLC
Zmag America, Ltd.

SHREDDERS

ATM Atilim Teknik Makine
Gillespie & Powers
Granutech – Saturn Systems
Quickdraft
Stedman Machine Company
Thorpe Technologies Inc.
Wendt Corporation

SORTING & SEPARATION SYSTEMS

ATM Atilim Teknik Makine
Eriez
Gillespie & Powers
Pyrotek
REDWAVE
Rigaku Analytical Devices
TOMRA Sorting Inc.
Thorpe Technologies Inc.
Wendt Corporation
Zmag America, Ltd.

SOW CASTING/ HANDLING EQUIPMENT

ALTEK
Bradley Lifting Corp.
EPIQ Machinery
GNA alutech inc.
Hertwich Engineering
Mansell and Associates
Mechatherm International Ltd.
Sistem Teknik Industrial Furnaces
STAS
Techmo Car S.p.A.
Wagstaff, Inc.

STIRRING/ VORTEXING EQUIPMENT

ABB Inc.
Almex USA Inc.
ALTEK
Conticast Hormesa LLC
Fives North American Combustion
Gillespie & Powers, Inc.
Hertwich Engineering
Mechatherm International
Pyrotek
RIA Cast House Engineering
Techmo Car S.p.A.
Thorpe Technologies Inc.
Wahl Refractory Solutions, LLC
Zmag America, Ltd.

STRAPPING/ PACKAGING

ATM Atilim Teknik Makine
EPIQ Machinery
Hertwich Engineering

TEMPERATURE MEASUREMENT/ CONTROL EQUIPMENT

Accurate Sensors Technologies Ltd.
Almex USA Inc.

AMETEK Land
ANDRITZ Metals USA Inc.
Anritsu Meter Co., Ltd.
Gillespie & Powers, Inc.
IMS Systems, Inc.
Innovatherm
Janus Automation
Major Furnace Australia Pty. Ltd.
Mechatherm International Ltd.
Pyrotek
STAS
Surface Combustion, Inc.
Thorpe Technologies Inc.
Wahl Refractory Solutions, LLC
Williamson Corp.

ULTRASONIC TESTING

Almex USA Inc.
EPIQ Machinery
Hertwich Engineering
HPI GmbH
Sistem Teknik Industrial Furnaces

USED EQUIPMENT (PRIMARY BUSINESS)

Phipps Company
RFTS LLC

VIBRATORY FEEDERS

ATM Atilim Teknik Makine
CitiUS Muhendislik
Eriez
Gillespie & Powers, Inc.
Inductotherm Corp.
Mansell and Associates
Thorpe Technologies Inc.

WEIGHING EQUIPMENT

EPIQ Machinery
Sistem Teknik Industrial Furnaces

List Your Company in Our Next Directory

To find out how to get your company listed in the next Directory of Secondary Aluminum Equipment Manufacturers & Suppliers, published in the August issue, email *Light Metal Age* at lma@lightmetalage.com, or call 650-588-8832 with your name and company contact information.

We also annually publish three more updated equipment supplier directories within the following issues: Primary Aluminum (February), Aluminum Extrusion (April), and Flat Rolled Aluminum (December).

In June, we combine all four directories into our *Master Directory*. It is available in both digital and hard copy format. The hard copy version is included with the June issue mailing.

To learn more, visit us at:
www.lightmetalage.com

Index to Directory of Flat Rolled Aluminum Equipment Manufacturers and Suppliers

| | |
|--|---|
| <p>Annealing Lines 34</p> <p>Automation/ Process Control Systems 34</p> <p>Baling/Briquetting Machines 34</p> <p>Coating Lines 34</p> <p>Coil Processing Systems 34</p> <p>Combustion Equipment/Gases 34</p> <p>Consultants (Primary Business) 35</p> <p>Continuous Caster Tips 35</p> <p>Continuous Casting Systems – Rod 35</p> <p>Continuous Casting Systems – Sheet/Strip 35</p> <p>Continuous Casting Systems – Slab, Ingot, T-Bar .. 35</p> <p>Cut-to-Length Lines 35</p> <p>Degassing 35</p> <p>Delacquering Equipment 36</p> <p>Doubling Machines 36</p> <p>Dross Removal/Cooling 36</p> <p>Edge Guiding Systems 36</p> <p>Education/Training 36</p> <p>Embossing Equipment 36</p> <p>Filtration Equipment, Molten Metal 36</p> <p>Filtration Systems, Coolant 36</p> <p>Flatness Measurement and Control Systems 36</p> <p>Flux/Fluxing 36</p> <p>Foil Processing Equipment 36</p> <p>Fume Extraction Systems 36</p> <p>Furnace Rebuilds 36</p> <p>Furnaces – Heat Treatment 36</p> <p>Furnaces – Melting and Holding 38</p> <p>Furnaces – Slab Heating 38</p> <p>Gauge Control Systems 38</p> <p>Gauges, Thickness 38</p> <p>Grain Refining 38</p> <p>Hydraulic Equipment 38</p> <p>Inspection Equipment/Analyzers 38</p> <p>Laser Marking/ Traceability 38</p> <p>Leveling Lines, Tension and Roller 38</p> | <p>Lubrication 38</p> <p>Lubrication – Casthouse Coatings 38</p> <p>Lubrication – Rolling Oils 38</p> <p>Material Handling Equipment 38</p> <p>Material Handling Equipment – Coil Carriers 40</p> <p>Material Handling Equipment – Coil Storage 40</p> <p>Material Handling Equipment – Transfer Cars 40</p> <p>Metal Level Controls/ Sensors 40</p> <p>Molds, Continuous Casting 40</p> <p>Plant Revamps/Equipment Retrofitting 40</p> <p>Pumps, Molten Metal 40</p> <p>Quality Control Test Equipment 40</p> <p>Refractories 40</p> <p>Rewinding Machines 40</p> <p>Roll Grinding Machines 40</p> <p>Rolling Mills – Cold 40</p> <p>Rolling Mills – Foil 40</p> <p>Rolling Mills – Hot 40</p> <p>Rolling Mills – Rod to Wire 41</p> <p>Rolls 41</p> <p>Sawing Machines and Cutting Tools 41</p> <p>Scrap Melting 41</p> <p>Scrap Preparation Equipment 41</p> <p>Separating Machines 41</p> <p>Shape Control Systems 41</p> <p>Simulation/Modeling/Software 41</p> <p>Slitting Lines 41</p> <p>Soaking Pits 41</p> <p>Spray Cooling/Heating Systems 41</p> <p>Stirrers 41</p> <p>Surface Treatment 41</p> <p>Temperature Measurement 41</p> <p>Used Equipment (Primary Business) 41</p> <p>Ventilation 41</p> |
|--|---|

Directory of Flat Rolled Aluminum Equipment Manufacturers and Suppliers Categories/Companies

| | | |
|--|--|---|
| <p>Annealing Lines</p> <p>ANDRITZ Metals USA Inc.</p> <p>Butech Bliss</p> <p>Chiz Bros.</p> <p>CitiUS Muhendislik</p> <p>Danieli & C.</p> <p>EBNER Furnaces, Inc.</p> <p>Gautschi Engineering GmbH</p> <p>HOWDEN Canada</p> <p>International Thermal Systems</p> <p>Otto Junker GmbH</p> <p>LOI Thermprocess GmbH</p> <p>MINO SpA</p> <p>Sistem Teknik Industrial Furnaces Ltd.</p> <p>SMS group Inc.</p> <p>Surface Combustion, Inc.</p> <p>Automation/ Process Control Systems</p> <p>ABB Inc.</p> <p>ABB Inc., Force Measurement</p> <p>Achenbach Buschhuetten GmbH</p> <p>Almex USA Inc.</p> <p>ALTEK</p> <p>ANDRITZ Metals USA Inc.</p> <p>B&O Saws, Inc.</p> <p>Burghardt + Schmidt GmbH</p> <p>Butech Bliss</p> <p>CitiUS Muhendislik</p> | <p>CNPT</p> <p>Danieli & C.</p> <p>EBNER Furnaces, Inc.</p> <p>Fives North American Combustion, Inc.</p> <p>Gautschi Engineering GmbH</p> <p>GNA alutech</p> <p>International Thermal Systems</p> <p>Janus Automation LLC</p> <p>LOI Thermprocess GmbH</p> <p>Mechatherm International Ltd.</p> <p>MINO SpA</p> <p>Precimeter Control AB</p> <p>Precimeter Inc.</p> <p>Primetals Technologies</p> <p>Ramboll</p> <p>Sermas</p> <p>Sistem Teknik Industrial Furnaces Ltd.</p> <p>SMS group Inc.</p> <p>Surface Combustion, Inc.</p> <p>Wagstaff, Inc.</p> <p>Baling/Briquetting Machines</p> <p>Danieli & C.</p> <p>Sermas</p> <p>Coating Lines</p> <p>ANDRITZ Metals USA Inc.</p> <p>Double Globus, Inc.</p> <p>EPCON Industrial Systems</p> | <p>FASPAR S.p.A.</p> <p>Globus S.r.l.</p> <p>Kampf Machinery Corporation</p> <p>Coil Processing Systems</p> <p>Achenbach Buschhuetten GmbH</p> <p>Alliance Machine and Engraving</p> <p>ANDRITZ Metals USA Inc.</p> <p>Burghardt + Schmidt GmbH</p> <p>Butech Bliss</p> <p>FASPAR S.p.A.</p> <p>GEORG North America Inc.</p> <p>HOWDEN Canada</p> <p>Janus Automation LLC</p> <p>MINO SpA</p> <p>Primetals Technologies</p> <p>Red Bud Industries</p> <p>SMS group Inc.</p> <p>Combustion Equipment/Gases</p> <p>Airgas, an Air Liquide Company</p> <p>Air Products</p> <p>AMETEK Land</p> <p>ANDRITZ Metals USA Inc.</p> <p>Bloom Engineering Inc.</p> <p>CETAG</p> <p>CitiUS Muhendislik</p> <p>EBNER Furnaces, Inc.</p> <p>Fives North American Combustion, Inc.</p> |
|--|--|---|

Directory of Flat Rolled Aluminum Equipment Manufacturers and Suppliers Categories/Companies

Gautschi Engineering GmbH
Gillespie & Powers, Inc.
HCT, part of Bloom Engineering
International Thermal Systems
Major Furnace Australia
Messer Americas
Sistem Teknik Industrial Furnaces Ltd.
Thorpe Technologies Inc.

Consultants (Primary Business)

Hatch
Innoval Technology
Oculatus Consulting
Ramboll
RFTS LLC

Continuous Caster Tips

Conticast Hormesa LLC
GES-AGM USA
Pyrotek
ZIRCAR Ceramics, Inc.

Continuous Casting Systems – Rod

Almex USA Inc.
Castal Engineering
Conticast Hormesa LLC
Continuus-Properzi
Dynamic Concept
Properzi International, Inc.

Southwire SCR Technologies

Continuous Casting Systems – Sheet/Strip

Castal Engineering
CitiUS Muhendislik
CNPT
Conticast Hormesa LLC
Hazelett Corporation
Novelis PAE
Bruno Presezzi SpA
Properzi International Inc.
Sistem Teknik Industrial Furnaces Ltd.
SMS group Inc.

Continuous Casting Systems – Slab, Ingot, T-Bar

Almex USA Inc.
Castal Engineering
CitiUS Muhendislik
CNPT
Conticast Hormesa LLC
Continuus-Properzi
Dynamic Concept
EPIQ Machinery
Hertwich Engineering
LOI Thermprocess GmbH
Novelis PAE
Properzi International, Inc.
Sistem Teknik Industrial Furnaces Ltd.

SMS group Inc.
Southwire SCR Technologies
STAS

Cut-to-Length Lines

Achenbach Buschhuetten GmbH
Advanced Machine & Engineering Co.
ANDRITZ Metals USA Inc.
Burghardt + Schmidt GmbH
Butech Bliss
CNPT
Continuus-Properzi
Danieli & C.
FASPAR S.p.A.
Friggi America
GEORG North America Inc.
Major Furnace Australia
August Mössner GmbH + Co. KG
Properzi International
Red Bud Industries
Seramas

Degassing

Air Products
Almex USA Inc.
CitiUS Muhendislik
CNPT
Conticast Hormesa LLC
Excellent Foundry Fluxes Company
Graphite Cova GmbH



Technology by SENSORY ANALYTICS

Still measuring coating thickness offline? What about the rest of the coil?

Introducing SpecMetrix® Coil Coating Thickness Measurement Systems: Game-changing non-contact and non-destructive in-process measurement systems for applied pretreatments, TOCs, primers, and topcoats. All SpecMetrix systems deliver real-time coating thickness data that streamline changeovers, optimize coating usage, and monitor coating quality. specmetrix.com | +1.336.315.6090

Directory of Flat Rolled Aluminum Equipment Manufacturers and Suppliers Categories/Companies

Hertwich Engineering
Molten Metal Equipment Innovations
Novelis PAE
Prezezzi Extrusion - Melting
Technology
Pyrotek
Scottish Chemical Industries
Sistem Teknik Industrial Furnaces Ltd.
SMS group Inc.
Southwire SCR Technologies
STAS
Wahl Refractory Solutions, LLC

Delacquering Equipment

Fives North American Combustion, Inc.
GHI Hornos Industriales
Gillespie & Powers, Inc.
GNA alutech
Mechatherm International Ltd.
Prezezzi Extrusion - Melting
Technology
Sistem Teknik Industrial Furnaces Ltd.
Thorpe Technologies Inc.

Doubling Machines

Achenbach Buschhuetten GmbH
CNPT
Kampf Machinery Corporation

Dross Removal/Cooling

ALTEK
CETAG
Conticast Hormesa LLC
Danieli & C.
EPIQ Machinery
Fives North American Combustion, Inc.
GHI Hornos Industriales
Mechatherm International Ltd.
Prezezzi Extrusion - Melting
Technology
Pyrotek
Sanshin Industry Ltd.
Scottish Chemical Industries
Sistem Teknik Industrial Furnaces Ltd.
STAS
T.T. Tomorrow Technology S.p.A.

Edge Guiding Systems

ABB Inc., Force Measurement
ANDRITZ Metals USA Inc.
Burghardt + Schmidt GmbH
Butech Bliss

Education/Training

Achenbach Buschhuetten GmbH
Almex USA Inc.
ANDRITZ Metals USA Inc.
Danieli & C.
Gillespie & Powers, Inc.
GHI Hornos Industriales
Hatch
Innoval Technology
SenTek Corporation
SMS group Inc.

Thorpe Technologies

Embossing Equipment

Alliance Machine and Engraving LLC
Double Globus, Inc.
FASPAR S.p.A.
Globus S.r.l.

Filtration Equipment, Molten Metal

Almex USA Inc.
Conticast Hormesa LLC
Continuus-Properzi
Drache Umwelttechnik GmbH
Dynamic Concept
Graphite Cova GmbH
Major Furnace Australia
Novelis PAE
Prezezzi Extrusion - Melting
Technology
Properzi International, Inc.
Pyrotek
Scottish Chemical Industries
Sistem Teknik Industrial Furnaces Ltd.
STAS
Urja Products Pvt. Ltd.

Filtration Systems, Coolant

Achenbach Buschhuetten GmbH
AMCOL Corporation
CECO Busch
Danieli & C.
Major Furnace Australia Pty. Ltd.
Primetals Technologies
Stines Equipment Company

Flatness Measurement and Control Systems

ABB Inc., Force Measurement
Achenbach Buschhuetten GmbH
ANDRITZ Metals USA Inc.
Butech Bliss
Danieli & C.
MINO SpA
Primetals Technologies

Flux/Fluxing

Excellent Foundry Fluxes Company
Graphite Cova GmbH
Molten Metal Equipment Innovations
Pyrotek
Scottish Chemical Industries
STAS

Foil Processing Equipment

Achenbach Buschhuetten GmbH
Butech Bliss
HOWDEN Canada
Otto Junker GmbH
Primetals Technologies
Surface Combustion, Inc.

Fume Extraction Systems

Achenbach Buschhuetten GmbH

CECO Busch
CNPT
Entecco Filter Technology
Fives North American Combustion, Inc.
Pittek Div., Swindell Dressler Intl.
Prezezzi Extrusion - Melting
Technology
Primetals Technologies
Sistem Teknik Industrial Furnaces Ltd.
SMS group Inc.
Stines Equipment Company

Furnace Rebuilds

ANDRITZ Metals USA Inc.
Chiz Bros.
CitiUS Muhendislik
Conticast Hormesa LLC
EBNER Furnaces, Inc.
Fives North American Combustion, Inc.
Furnace Engineering Pty. Ltd.
Gautschi Engineering GmbH
Gillespie & Powers, Inc.
GNA alutech
HCT, part of Bloom Engineering
HOWDEN Canada
Inductotherm Corp.
International Thermal Systems
Otto Junker GmbH
LOI Thermprocess GmbH
Major Furnace Australia Pty. Ltd.
Prezezzi Extrusion - Melting
Technology
Pyrotek
SECO/Warwick Corporation
Sistem Teknik Industrial Furnaces Ltd.
SMS group Inc.
Thorpe Technologies Inc.
Wahl Refractory Solutions, LLC

Furnaces – Heat Treatment

Almex USA Inc.
ANDRITZ Metals USA Inc.
Can-Eng Furnaces International Ltd.
Chiz Bros.
CitiUS Muhendislik
CNPT
Conticast Hormesa LLC
Danieli & C.
EBNER Furnaces, Inc.
EFR-John Cockerill
EPCON Industrial Systems
Fives North American Combustion, Inc.
Gautschi Engineering GmbH
GHI Smart Furnace
Gillespie & Powers, Inc.
GNA alutech inc.
Graphite Cova GmbH
Hertwich Engineering
HOWDEN Canada
International Thermal Systems
Otto Junker GmbH
LOI Thermprocess GmbH
Major Furnace Australia
Mechatherm International Ltd.

USControls®

World Leading Rolling Mill Spray Systems

US Controls designs and manufactures the best valves in the industry. Our latest design builds on our proven 94lpm (or 25gpm) valve and reduces it into a smaller package, making it ideal for any application.

World's Most Reliable Water-Soluble Valve is

NOW 25% SMALLER!

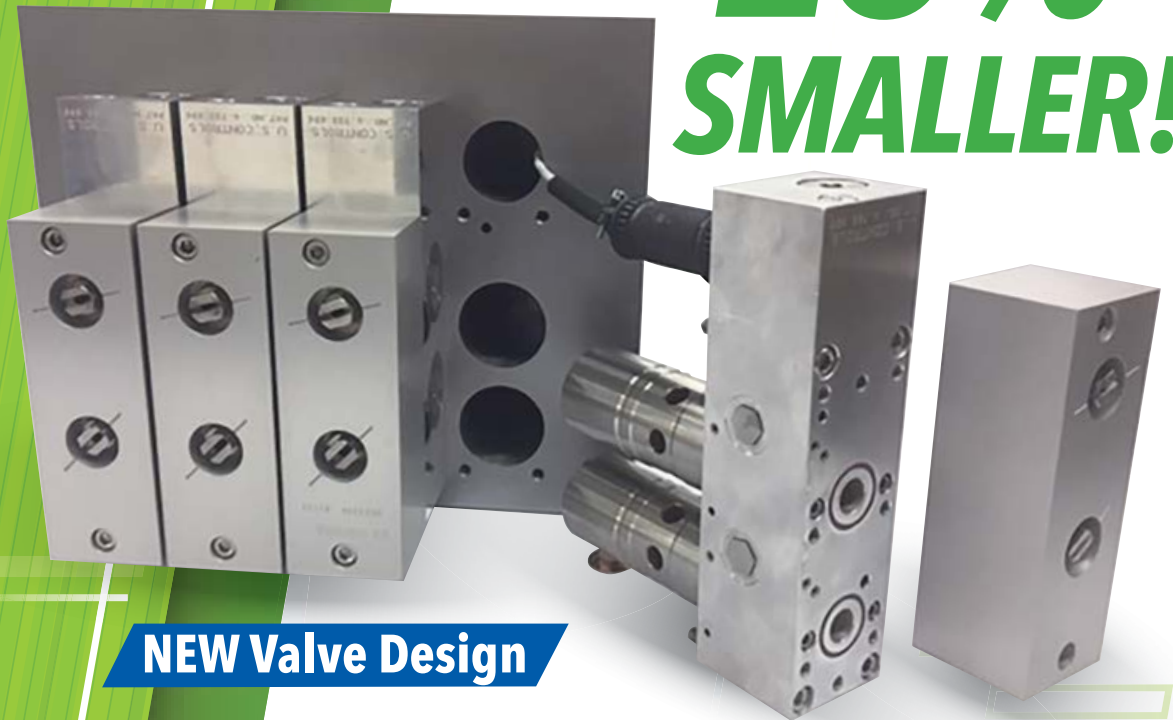

NEW Valve Design

- 25% Smaller - Fits into Tighter Spaces
- Maintenance - More Room to Work
- Engineering - More Room to Design Into Tight-fitting Areas
- Same Moving Parts as the World Beating 94LPM Valve
- Common Replacement Parts

The 97lpm Valve Series is still the same maintenance friendly valve design for quick troubleshooting and replacement.

MADE IN USA



US CONTROLS
CONTACTS:

Ken Flowers – USC Global Director of Sales
PH: 330.257.9753 (Cell)
Email: kenflowers@unitedstatescontrols.com

Lisa Quinn – Commercial Manager
PH: 330.758.1147 ext. 104
Email: lquinn@unitedstatescontrols.com

Directory of Flat Rolled Aluminum Equipment Manufacturers and Suppliers Categories/Companies

Prezezzi Extrusion – Melting Technology
SECO/Warwick Corporation
Sistem Teknik Industrial Furnaces Ltd.
SMS group Inc.
Surface Combustion, Inc.
Thorpe Technologies Inc.

Furnaces – Melting and Holding

Almex USA Inc.
ANDRITZ Metals USA Inc.
Castal Engineering
CETAG
Chiz Bros.
CitiUS Muhendislik
CNPT
Contincast Hormesa LLC
Continuus-Properti
Danieli & C.
EFR–John Cockerill
Fives North American Combustion, Inc.
Gautschi Engineering GmbH
GHI Smart Furnaces
Gillespie & Powers, Inc.
GNA alutech inc.
Hertwich Engineering
HOWDEN Canada
Inductotherm Corp.
Otto Junker GmbH
LOI Thermprocess GmbH
Major Furnace Australia
Mechatherm International Ltd.
Prezezzi Extrusion – Melting Technology
Properti International, Inc.
SECO/Warwick Corporation
Sistem Teknik Industrial Furnaces Ltd.
SMS group Inc.
Thorpe Technologies Inc.

Furnaces – Slab Heating

Almex USA Inc.
ANDRITZ Metals USA Inc.
Chiz Bros.
CitiUS Muhendislik
CNPT
Conticast Hormesa LLC
Danieli & C.
EBNER Furnaces, Inc.
EFR–John Cockerill
Fives North American Combustion, Inc.
Gautschi Engineering GmbH
GHI Hornos Industriales
Gillespie & Powers
HOWDEN Canada
Inductotherm Corp.
International Thermal Systems
Otto Junker GmbH
Major Furnace Australia
Mechatherm International Ltd.
SECO/Warwick Corporation
Sistem Teknik Industrial Furnaces Ltd.

Gauge Control Systems

ABB Inc., Force Measurement
Achenbach Buschhuetten GmbH
ANDRITZ Metals USA Inc.
Butech Bliss
Can-Eng Furnaces International Ltd.
Danieli & C.
MINO SpA
Primetals Technologies
SMS group Inc.

Gauges, Thickness

ABB Inc., Force Measurement
Achenbach Buschhuetten GmbH
ANDRITZ Metals USA Inc.
Butech Bliss
Danieli & C.
Sensory Analytics (SpecMetrix Systems)
SenTek Corporation

Grain Refining

CETAG
CitiUS Muhendislik
Hertwich Engineering
Major Furnace Australia
Mechatherm International Ltd.
MQP Limited
Scottish Chemical Industries
Sistem Teknik Industrial Furnaces Ltd.
Southwire SCR Technologies
STAS

Hydraulic Equipment

Almex USA Inc.
ANDRITZ Metals USA Inc.
Butech Bliss
Hastec Group Inc./Hastec Rebs Inc.
Major Furnace Australia Pty. Ltd.
Primetals Technologies
SMS group Inc.

Inspection Equipment/ Analyzers

ABB Inc., Force Measurement
Almex USA Inc.
Dynamic Concept
Herkules North America
Kampf Machinery Corporation
Sensory Analytics (SpecMetrix Systems)

Laser Marking/Traceability

Dynamic Concept
Laserax
STAS

Leveling Lines, Tension and Roller

ANDRITZ Metals USA Inc.
Burghardt + Schmidt GmbH
Butech Bliss
CNPT
Danieli & C.

Double Globus, Inc.
FASPAR S.p.A.
GEORG North America
Globus S.r.l.
Kampf Machinery Corporation
Red Bud Industries

Lubrication

AMCOL Corporation
Condat Lubricants
Hastec Group Inc./Hastec Rebs Inc.
ITW Pro Bands
Major Furnace Australia
Pyrotek
Scottish Chemical Industries
Sermas
TotalEnergies Marketing USA
ZIRCAR Ceramics, Inc.

Lubrication – Casthouse Coatings

AMCOL Corporation
Condat Lubricants
GES-AGM USA
Major Furnace Australia
Pyrotek
Scottish Chemical Industries
TotalEnergies Marketing USA
ZIRCAR Ceramics, Inc.

Lubrication – Rolling Oils

Achenbach Buschhuetten GmbH
AMCOL Corporation
Condat Lubricants
Major Furnace Australia
Quaker Houghton
Scottish Chemical Industries
TotalEnergies Marketing USA

Material Handling Equipment

Achenbach Buschhuetten GmbH
Advanced Machine & Engineering Co.
ALTEK
B&O Saws, Inc.
Bradley Lifting Corp.
Butech Bliss
Daifuku America Corporation
Danieli + C.
EPIQ Machinery
Fives North American Combustion, Inc.
Friggi America
Hertwich Engineering
Inductotherm
Irwin Car and Equipment
Otto Junker GmbH
Mechatherm International Ltd.
Primetals Technologies
Sermas
Sistem Teknik Industrial Furnaces Ltd.
SMS group Inc.
STAS
T.T. Tomorrow Technology S.p.A.

Directory of Flat Rolled Aluminum Equipment Manufacturers and Suppliers Categories/Companies

Material Handling Equipment – Coil Carriers

Achenbach Buschhuetten GmbH
Burghardt + Schmidt GmbH
Butech Bliss
Chiz Bros.
Danieli & C.
EPIQ Machinery
Irwin Car and Equipment
Otto Junker GmbH
Primetals Technologies
Red Bud Industries
Sistem Teknik Industrial Furnaces Ltd.
T.T. Tomorrow Technology S.p.A.

Material Handling Equipment – Coil Storage

Burghardt + Schmidt GmbH
Butech Bliss
Danieli & C.
Irwin Car and Equipment
Primetals Technologies
Red Bud Industries

Material Handling Equipment – Transfer Cars

ALTEK
ANDRITZ Metals USA Inc.
Burghardt + Schmidt GmbH
Butech Bliss
CitiUS Muhendislik
Danieli & C.
GNA alutech
International Thermal Systems
Irwin Car and Equipment
Otto Junker GmbH
Primetals Technologies
Red Bud Industries
Sermas
Sistem Teknik Industrial Furnaces Ltd.
T.T. Tomorrow Technology S.p.A.

Metal Level Controls/Sensors

ABB Inc., Force Measurement
Almex USA Inc.
ANDRITZ Metals USA Inc.
Butech Bliss
Conticast Hormesa LLC
Danieli & C.
Dynamic Concept
Janus Automation LLC
Mechatherm International Ltd.
Novelis PAE
Precimeter Control AB
Precimeter Inc.
Scottish Chemical Industries
SMS group Inc.
STAS
Wagstaff, Inc.

Molds, Continuous Casting

Almex USA Inc.
ALTEK
Butech Bliss

Conticast Hormesa LLC
Dynamic Concept
EPIQ Machinery
Gautschi Engineering GmbH
GES-AGM USA
Graphite Cova
Novelis PAE
Pyrotek
Scottish Chemical Industries
SMS group Inc.

Plant Revamps/Equipment Retrofitting

Achenbach Buschhuetten GmbH
Almex USA Inc.
ANDRITZ Metals USA Inc.
Burghardt + Schmidt GmbH
Butech Bliss
Danieli & C.
EPIQ Machinery
Fives North American Combustion, Inc.
Gautschi Engineering GmbH
Gillespie & Powers, Inc.
GNA alutech
Herkules North America
Janus Automation LLC
Otto Junker GmbH
LOI Thermprocess GmbH
Major Furnace Australia Pty. Ltd.
Mechatherm International Ltd.
MINO SpA
Precimeter Control AB
Presezzi Extrusion – Melting
Technology
Bruno Presezzi SpA
Primetals Technologies
SMS group Inc.
Thorpe Technologies Inc.
Wahl Refractory Solutions, LLC

Pumps, Molten Metal

ABB Inc.
CitiUS Muhendislik
Fives North American Combustion, Inc.
GES-AGM USA
Graphite Cova GmbH
Major Furnace Australia
Molten Metal Equipment Innovations
Precimeter Control AB
Pyrotek
Sistem Teknik Industrial Furnaces Ltd.
Zmag America, Ltd.

Quality Control Test Equipment

ALTEK
ISRA Vision Parsytec
Janus Automation LLC
Sensory Analytics (SpecMetrix
Systems)
Taber Industries

Refractories

Chiz Bros.
Conticast Hormesa LLC

Drache Umwelttechnik GmbH
Fives North American Combustion, Inc.
Foundry Service & Supplies, Inc.
GES-AGM USA
Gillespie & Powers, Inc.
Graphite Cova GmbH
Insulation Specialties of America
Major Furnace Australia
Murlin Chemical, Inc.
Plibrico Company, LLC
Pyrotek
Refractory Technology LLC
Scottish Chemical Industries
Thorpe Technologies Inc.
Wahl Refractory Solutions, LLC

Rewinding Machines

Achenbach Buschhuetten GmbH
ANDRITZ Metals USA Inc.
Burghardt + Schmidt GmbH
Butech Bliss
CNPT
Danieli & C.
Double Globus, Inc.
Globus S.r.l.
Kampf Machinery Corporation
Primetals Technologies

Roll Grinding Machines

ANDRITZ Metals USA Inc.
GEORG North America Inc.
Herkules North America
Major Furnace Australia
SMS group Inc.

Rolling Mills – Cold

Achenbach Buschhuetten GmbH
ANDRITZ Metals USA Inc.
Butech Bliss
Castal Engineering
CNPT
Continuus-Properti S.P.A.
Danieli & C.
Herkules North America
Major Furnace Australia
MINO SpA
Primetals Technologies
Properti International, Inc.
SMS group Inc.

Rolling Mills – Foil

Achenbach Buschhuetten GmbH
Butech Bliss
Castal Engineering
CNPT
Danieli & C.
Herkules North America
Major Furnace Australia
MINO SpA
Primetals Technologies

Rolling Mills – Hot

Achenbach Buschhuetten GmbH
ANDRITZ Metals USA Inc.

Directory of Flat Rolled Aluminum Equipment Manufacturers and Suppliers Categories/Companies

Butech Bliss
Castal Engineering
CNPT
Continuus-Properzi
Danieli & C.
Herkules North America
Major Furnace Australia
MINO SpA
Primetals Technologies
Properzi International, Inc.
SMS group Inc.

Rolling Mills – Rod to Wire

Continuus-Properzi
Herkules North America
Major Furnace Australia
Primetals Technologies
Properzi International, Inc.

Rolls

ANDRITZ Metals USA Inc.
Butech Bliss
Continuus-Properzi
Praxair Surface Technologies, a
Linde Company
Properzi International, Inc.

Sawing Machines and Cutting Tools

Advanced Machine & Engineering Co.
B&O Saws, Inc.
CitiUS Muhendislik
Conticast Hormesa LLC
EPIQ Machinery
Friggi America
Hertwich Engineering
August Mössner GmbH + Co. KG
Sermas
Sistem Teknik Industrial Furnaces Ltd.
SMS group Inc.
STAS
The L.S. Starrett Co.
Starcut SRL

Scrap Melting

Almex USA Inc.
ANDRITZ Metals USA Inc.
CitiUS Muhendislik
Continuus-Properzi
Danieli & C.
Fives North American Combustion, Inc.
Gautschi Engineering GmbH
Gillespie & Powers, Inc.
GNA alutech inc.
Hertwich Engineering
HOWDEN Canada
Inductotherm Corp.
Otto Junker GmbH
LOI Thermprocess GmbH
Mechatherm International Ltd.
Prezezzi Extrusion – Melting
Technology
Properzi International, Inc.
Pyrotek

Scottish Chemical Industries
Sistem Teknik Industrial Furnaces Ltd.
Thorpe Technologies Inc.
T.T. Tomorrow Technology S.p.A.
Zmag America, Ltd.

Scrap Preparation Equipment

Burghardt + Schmidt GmbH
Butech Bliss
Danieli & C.
EPIQ Machinery
Pyrotek
Sistem Teknik Industrial Furnaces Ltd.

Separating Machines

Achenbach Buschhuetten GmbH
Kampf Machinery Corporation
Pyrotek
Scottish Chemical Industries

Shape Control Systems

ABB Inc., Force Measurement
Achenbach Buschhuetten GmbH
ANDRITZ Metals USA Inc.
CNPT
Danieli & C.
MINO SpA
Primetals Technologies
SenTek Corporation
SMS group Inc.

Simulation/Modeling/Software

Achenbach Buschhuetten GmbH
ANDRITZ Metals USA Inc.
Conticast Hormesa LLC
Danieli & C.
Hatch
Innoval Technology
Janus Automation LLC
MINO SpA
Stines Equipment Company

Slitting Lines

Achenbach Buschhuetten GmbH
ANDRITZ Metals USA Inc.
Burghardt + Schmidt GmbH
Butech Bliss
CNPT
Danieli & C.
FASPAR S.p.A.
GEORG North America Inc.
Kampf Machinery Corporation
Red Bud Industries
SMS group Inc.

Soaking Pits

ANDRITZ Metals USA Inc.
Chiz Bros.
Danieli & C.
EBNER Furnaces, Inc.
Fives North American Combustion, Inc.
HOWDEN Canada
Otto Junker GmbH
Sistem Teknik Industrial Furnaces

Spray Cooling/Heating Systems

Achenbach Buschhuetten GmbH
AMCOL Corporation
Otto Junker GmbH
Primetals Technologies
SenTek Corporation
SMS group Inc.
United States Controls, Inc.

Stirrers

ABB Inc.
ABB Inc., Force Measurement
ALTEK
CitiUS Muhendislik
Hertwich Engineering
Prezezzi Extrusion - Melting
Technology
Pyrotek
Scottish Chemical Industries
Sistem Teknik Industrial Furnaces
Zmag America, Ltd.

Surface Treatment

AMETEK Surface Vision
ANDRITZ Metals USA Inc.
CNPT
Double Globus, Inc.
Globus S.r.l.
Otto Junker GmbH
Major Furnace Australia
Praxair Surface Technologies, a
Linde Company

Temperature Measurement

ABB Inc., Force Measurement
Accurate Sensors Technologies Ltd.
Almex USA Inc.
AMETEK Land
Anritsu Meter Co., Ltd.
GNA alutech
Mechatherm International Ltd.
Pyrotek
Scottish Chemical Industries
STAS
Williamson Corporation

Used Equipment (Primary Business)

Machinery International Corp.
National Machinery Exchange
Phipps Company
RFTS LLC

Ventilation

CECO Busch
Entecco Filter Technology
Pittek Div., Swindell Dressler Intl.
Stines Equipment Company

Alphabetical List of Companies

02 Environmental Technologies Inc.

Chapel Hill, NC
randy@qamanage.com
www.qamanage.com
Contact: Randal Galloway

4 MI GmbH

Malsburg-Marzell, Germany
daniel.seifert@4mi-gmbh.de
www.4mi-gmbh.com
Contact: Daniel Seifert

A.T.I.E. Uno Informatica SRL

Lecco (LC), Italy
sales@atieuno.com
www.atieuno.com
Contact: Pierpaolo Longhi

ABB Inc.

Whitby, ON, Canada
krystal.f.futter@ca.abb.com
www.abb.com
Contact: Krystal Futter

ABB Inc., Force Measurement Product Group

Danbury, CT
forcemeasurement@us.abb.com
new.abb.com/products/
measurement-products
Contact: Steve Reichert

ABB Measurement & Analytics

Quebec, QC, Canada
guillaume.a.coulombe@ca.abb.com
www.abb.com/analytical
Contact: Guillaume Coulombe

Abtex, LLC

Dresden, NY
ljohnson@abtex.com
www.abtex.com
Contact: Larry Johnson

Accurate Sensors Technologies Ltd.

Misgav, Israel
ast@accuratesensors.com
www.accuratesensors.com
Contact: Hadas Yoely

Achenbach Büschhuetten GmbH & Co. KG

Kreuztal, Germany
info@achenbach.de
www.achenbach.de
Contact: Sales Department

Additive Solutions Ltd.

Zurich, Switzerland
info@additive-solutions.com

www.additive-solutions.com
Contact: Product Manager

Adex B.V.

PZ Venlo, The Netherlands
sales@adex-dies.com
www.adex-dies.com
Contact: Louis Coopmans

Advanced Machine & Engineering

Rockford, IL
steveswanson@ame.com
www.ame.com
Contact: Steve Swanson

Advanced Technical Products

West Chester, OH
atp@advancedtechnicalprod.com
www.advancedtechnicalprod.com
Contact: Tim Conner

Adwest Technologies Inc. – A CECO Environmental Company

Fullerton, CA
bcannon@onececo.com
www.adwestusa.com
Contact: Brian Cannon

Air Products

Allentown, PA
info@airproducts.com
www.airproducts.com/nonferrous
Contact: Marie Kistler

Air-Therm Inc.

Montreal, QC, Canada
egbaltuch@air-therm.com
www.air-therm.com
Contact: Ted Baltuch

Airgas, an Air Liquide Company

Twinsburg, OH
william.ollerton@airgas.com
www.airgas.com
Contact: William Ollerton

Ajax/CECO/Erie Press

Erie, PA
klowry@ajaxerie.com
www.ajaxerie.com
Contact: Kim Lowry

AK Corporation

Sejong-si, Republic of Korea
jongheon.kim@akglobal.net
www.akglobal.net
Contact: Jongheon Kim

Albarrie Canada Limited

Barrie, ON, Canada
apcfabrics@albarrie.com

www.albarrie.com
Contact: Ralph Schors

Alcoa USA Corp.

Knoxville, TN
angelena.ellis@alcoa.com
www.alcoa.com
Contact: Angelena Ellis

Alliance Machine and Engraving LLC

Ashland, VA
bfoster@alliancemachine
andengraving.com
www.alliancemachine
andengraving.com
Contact: F. Bradley Foster

ALMAX MORI

Mori (TN), Italy
sales@almex-mori.it
www.linkedin.com/company/
almex-mori
Contact: Tommaso Pinter

Almex USA, Inc.

Buena Park, CA
info@almexusa.com
www.almexusa.com
Contact: Subal Mehta

ALTEK

Malvern, PA
sales@altek-al.com
www.altek-al.com
Contact: James Herbert

AluCellTech Inc.

Oakville, ON, Canada
sales@alucelltech.com
www.alucelltech.com
Contact: Will Berends

AluConsult

Trustrup, Denmark
adj@aluconsult.com
www.aluconsult.com
Contact: Anne Deacon Juhl

Aluminum Casting Technologies LLC

Old Tappan, NJ
johnvj@optonline.net
Contact: John Griffin

Aluminum Extrusion MarketPlace, LLC

Cookeville, TN
dturnipseed@aemarketplace.com
www.aemarketplace.com
Contact: David Turnipseed

Alphabetical List of Companies

AMCOL Corporation

Hazel Park, MI
info@amcolcorp.com
www.amcolcorp.com
Contact: Jim Dyla

AMETEK Land

Dronfield, U.K.
josh.bagnall@ametek.com
www.ametek-land.com
Contact: Josh Bagnall

AMETEK Surface Vision

Hayward, CA
surfacevision.info@ametek.com
www.ameteksurfacevision.com
Contact: Lucy Lambertsen

ANDRITZ Metals USA Inc.

Callery, PA
metals.usa@andritz.com
www.andritz.com/metals
Contact: Crystal Martin

Anodize USA

Ladson, SC
dnosti@anodizeusa.com
www.anodizeusa.com
Contact: Drew Nosti

Anodizing Technologies, Inc.

Indianapolis, IN
larry@anodizingtechnologies.com
www.anodizingtechnologies.com
Contact: Larry Chesterfield

Anritsu Meter Co., Ltd. (Shinyei Corporation of America)

New York, NY
sensor@sca-shinyei.com
www.sca-shinyei.com/anritsu/
products
Contact: Tony Tokuya

ATHERM

Domène, France
t.albertin@atherm.net
www.atherm.com
Contact: Thomas Albertin

ATM Atilim Teknik Makine

ANKARA, Turkey
info@atilimteknik.com.tr
www.atilimteknik.com.tr
Contact: Tuba Erden

August Mössner GmbH + Co. KG

Eschach, Germany
post@moessner-kg.de
www.moessner-kg.de
Contact: Oliver Vogt

AZON

Kalamazoo, MI
tbgroup@azonusa.com
www.azonintl.com
Contact: Sales

B&O Saws

Belding, MI
sales@bosaws.com
www.bosaws.com
Contact: Jon Kohn

Bawtry Carbon International Ltd.

Austerfield, Doncaster, U.K.
mike.sanderson@
bawtrycarbon.com
Contact: Mike Sanderson

Behringer Saws, Inc.

Morgantown, PA
info@usa.behringer.net
www.behringersaws.com
Contact: Joe Suydam

Belco Industries, Inc.

Belding, MI
ckohn@belcoind.com
www.belcoind.com
Contact: Chris Kohn

Bloom Engineering Inc.

Pittsburgh, PA
jcheckeye@bloomeng.com
www.bloomeng.com
Contact: Jim Checkeye

BOHLER

Walnut, CA
tyler.mcquown@edro.com
www.bohler.com
Contact: Tyler McQuown

Bosch Rexroth

Bethlehem, PA
michael.kramer@
boschrexroth-us.com
www.boschrexroth-us.com
Contact: Michael Kramer

Bradley Lifting Corp.

York, PA
sales@bradleylifting.com
www.bradleylifting.com
Contact: Sales

Brilex Technical Solutions

Youngstown, OH
jvital@brilex.com
www.brilextechnical.com/
heavypress
Contact: Josh Vitale

Bruno Prezezi SpA

Burago di Molgora, MB, Italy
aluminium.dept@
brunoprezezi.com
www.brunoprezezi.com
Contact: Franco La Malfa

Buelmann US LP

Vienna, OH
gb@buelmann.com
www.buelmann.com
Contact: George Burnet

Burghardt + Schmidt GmbH

Remchingen, Germany
f.kunz@b-s-germany.com
www.b-s-germany.com
Contact: Fabian Kunz

Buss ChemTech AG

Pratteln, Switzerland
info@buss-ct.com
www.buss-ct.com
Contact: Sales

Butech Bliss

Salem, OH
lkravec@butech.com
www.butechbliss.com
Contact: Lisa Kravec

Calderys

Paris, France
sebastien.duguet@calderys.com
www.calderys.com
Contact: Sebastien Duguet

Can-Eng Furnaces International Ltd.

Niagara Falls, ON, Canada
eratskos@can-eng.com
www.can-eng.com
Contact: Emillea Ratskos

Carco America

Cleveland, OH
jerry.kreiner@carcoprp.com
www.carcoseal.com
Contact: Jerry Kreiner

Carlesa NDE Services

Hanson, MA
ronmanganello@presstest.com
www.presstest.com
Contact: Ronald Manganello

Alphabetical List of Companies

Castal Engineering

Kifisia, Greece
castal@otenet.gr
www.castal.gr
Contact: Faidon Samaropoulos

Castool Tooling Systems

Uxbridge, ON, Canada
info@castool.com
www.castool.com
Contact: Dan Dunn

CECO Busch

Wexford, PA
bfrank@onececo.com
www.cecoenviro.com/busch
Contact: Bill Frank

CETAG – Casthouse Engineering and Technology AG

Lippoldswilen, Switzerland
om@cetag.swiss
www.cetag.swiss
Contact: Oliver Moos

Chiz Bros

Elizabeth, PA
mrhoajr@chizbros.com
www.chizbros.com
Contact: Mark Rhoa Jr.

CitiUS Muhendislik

Kadiköy, Istanbul, Turkey
erdal.sahin@citiusmuhendislik.com
www.citiusmuhendislik.com
Contact: Erdal Sahin

CJi Systems, Inc.

Walla Walla, WA
craig.johnson@cjisystems.com
www.cjisystems.com
Contact: Craig Johnson

Clariant International Ltd.

Muttenz, Switzerland
www.clariant.com
Contact: Sales Department

CNPT - China Nonferrous Metals Processing Technology Co., Ltd.

Luoyang, Henan, China
hancnpt@163.com
www.cnpt.com.cn
Contact: Han Zhengying

COIM srl

Castelcovati (BS), Italy
g.barbieri@coimsrl.net
www.coimsrl.net
Contact: Giancarlo Barbieri

Combilift

Greensboro, NC
info@combilift.com
www.combilift.com/us
Contact: Sales

Cometal Engineering SpA

Montichiari (BS), Italy
stefano.mancini@cometaleng.com
www.cometaleng.eu
Contact: Stefano Mancini

Compes International

Brampton, ON, Canada
orders@compes.ca
www.compes.ca
Contact: Sal Adamo

Compes S.P.A.

Rodengo Saiano (BS), Italy
info@compes.com
www.compes.com
Contact: Vincenzo Giacomelli

Condat Lubricants

Chasse-Sur-Rhone, France
info@condat.fr
www.condat-lubricants.com
Contact: Franck Dufresne

Conticast Hormesa LLC

Weston, FL
jquintero@hormesa.com
www.conticast.com
Contact: Julio Mauricio Quintero

Continuus-Properzi S.P.A.

Sordio, Lodi, Italy
sales@properzi.it
www.properzi.com
Contact: Giulio Properzi

Cunningham Extrusion Services

Pittsburg, PA
jcunningham@extrudehelp.com
www.extrudehelp.com
Contact: James Cunningham

Daifuku America Corporation

Reynoldsburg, OH
dacproductsales@daifukuamerica.com
www.daifuku.com
Contact: Russel Pruyt

Danieli Breda

Buttrio (UD), Italy
d.bracesco@danieli.it
www.danieli.com
Contact: Dario Bracesco

Die Cleaning Equipment & Supply, Inc.

Phoenix, AZ
nicole@diecleaningequipment.com
www.diecleaningequipment.com
Contact: Nicole Rizzo

Dienamex

St. Eustache, QC, Canada
info@dienamex.com
www.dienamex.com
Contact: Giuseppe Olcelli

Double Globus, Inc.

Highland, CA
bob.lukacs@globus-eng.com
www.globus-eng.com
Contact: Robert Lukacs

Drache Umweltechnik GmbH

Diez, Germany
mail@drache-gmbh.de
www.drache-gmbh.de
Contact: Sales Dept.

DUNAWAY

Canfield, OH
jason@dunawayinc.com
www.dunawayinc.com
Contact: Jason Markijohn

Dynamic Concept

Saguenay, QC, Canada
patrice.cote@dynamic-concept.com
www.dynamic-concept.com
Contact: Patrice Cote

Ebner Furnaces, Inc.

Wadsworth, OH
bj@ebnerfurnaces.com
www.ebnerfurnaces.com
Contact: B.J. Austin

Ecofill USA

Ontario, CA
j.harmsen@ecofillusa.com
www.ecofill.com
Contact: Jerome Harmsen

EDRO Specialty Steels

Ellwood City, PA
tyler.mcquown@edro.com
www.edro.com
Contact: Tyler McQuown

EFR - John Cockerill

Lyon, France
info@fours-efr.com
www.fours-efr.com
Contact: Eric Edel

Alphabetical List of Companies

Eirich (Maschinenfabrik Gustav Eirich GmbH & Co. KG)

Hardheim, Germany
eirich@eirich.de
www.eirich.com
Contact: Sales

Elite Extrusion Die Ltd.

Brockworth, Gloucestershire, U.K.
info@elitedie.co.uk
www.elitedie.co.uk
Contact: Steve Rogers

ELLWOOD Aluminum

Hubbard, OH
easales@elwd.com
www.ellwoodaluminum.com
Contact: Brad Craven

Emirates Global Aluminium (EGA)

KIZAD, Abu Dhabi, UAE
falmutawa@ega.ae
www.ega.ae
Contact: Fatima Al Mutawa

emmebi srl

Pavia Di Udine, UD, Italy
emmebi@emmebi.net
www.emmebi.net
Contact: Elena Mauro

EMV Technologies LLC

Blue Bell, PA
wzm2@lehigh.edu
Contact: Wojciech Misiolek

Entecco Filter Technology USA

High Point, NC
edgerton@entecco.com
www.entecco.com
Contact: David Edgerton

EPCON Industrial Systems

The Woodlands, TX
epcon@epconlp.com
www.epconlp.com
Contact: Shan Jamaluddin

EPIQ Machinery

Saint-Bruno, QC, Canada
marty.degoey@epiqmachinery.com
www.epiqmachinery.com
Contact: Marty Degoey

Eriez

Erie, PA
jblicha@eriez.com
www.eriez.com
Contact: John Blicha

Excellent Foundry Fluxes Company

New Delhi, India
exflux@gmail.com
www.excellentproducts.co.in
Contact: V.P. Sharma

EXCO Brasil

Sorocaba, SP, Brasil
anorberto@etsdies.com
www.etsdies.com
Contact: Andre Norberto

EXCO Canada

Markham, ON, Canada
terryclarke@excoglobal.com
www.etsdies.com
Contact: Terry Clarke

EXCO Colombia

Rionegro (Ant), Colombia
mrobbins@etsdies.com
www.etsdies.com
Contact: Mathew Robbins

EXCO Mexico

Huimilpan Queretaro, CP, Mexico
benmartinez@excoglobal.com
www.etsdies.com
Contact: Ben Martinez

EXCO Michigan

Chesterfield, MI
terryclarke@excoglobal.com
www.etsdies.com
Contact: Terry Clarke

EXCO Texas

Wylie, TX
terryclarke@excoglobal.com
www.etsdies.com
Contact: Terry Clarke

Extral Technology

Castelli Calepio (BG), Italy
tom@extrusionsupplies.com
www.extraltechnology.it
Contact: Tom Nentwick

ExtrusionSupplies

Canfield, OH
tom@extrusionsupplies.com
www.extrusionsupplies.com
Contact: Tom Nentwick

extrutec GmbH

Moos, Germany
info@extrutec-gmbh.de
www.extrutec-gmbh.de
Contact: Ulrich Bucher

extrutec N.A. Inc.

Cedar Springs, MI
werner@extrutec-gmbh.de
www.extrutec-gmbh.de
Contact: Michael Werner

FASPAR S.p.A.

Roxboro, NC
sales@phippsmetals.com
www.faspar.it
Contact: Ron Phipps

Fives ECL

Ronchin, France
fabienne.virieux@fivesgroup.com
www.fivesgroup.com
Contact: Fabienne Virieux

Fives North American Combustion, Inc.

Cleveland, OH
fna.sales@fivesgroup.com
combustion.fivesgroup.com
Contact: Fives NA Sales

Fives Solios

Givors, Rhone, France
fabienne.virieux@fivesgroup.com
www.fivesgroup.com
Contact: Fabienne Virieux

Foshan ABD Equipment Co., Ltd.

Guangdong Province, China
info@fsabd.com
www.fsabd.com/en/index.php
Contact: Cindy Hongwei

Foundry Service & Supplies, Inc.

Ontario, CA
dave@foundryservice.com
www.foundryservice.com
Contact: Dave Quayle

Foy Inc.

Farmersville, TX
info@foyinc.com
www.foyinc.com
Contact: Jim Foy

Friggi America

Woodstock, ON, Canada
info@friggiamerica.com
www.friggiamerica.com
Contact: Ben Fuschino

GAP Engineering SA

Chalais, Switzerland
info@gap-engineering.ch
www.gap-engineering.ch
Contact: Julien Valloton



ExtrusionSupplies

WE SUPPLY THE ALUMINUM EXTRUDER

**NEW AND USED
COMPLETE EXTRUSION LINES, HANDLING SYSTEMS,
DIE OVENS, SPACER BAR COVERS, KEVLAR PRODUCTS,
AND LOG FURNACE/SHEARS, ETC.
WE HAVE YOU COVERED**



Extral Technology complete extrusion lines. World class automation!
Thermika IR Die Ovens Kevlar Felt and Spacer Bar Covers

www.extrusionsupplies.com

Contact: Tom Nentwick

Mobile: (330) 506-9291

Email: tom@extrusionsupplies.com

Alphabetical List of Companies

Gautschi Engineering GmbH
Braunau-Ranshofen, Austria
info@gautschi.cc
www.gautschi.cc
Contact: Oliver Jansen

Georg North America Inc.
Roanoke, VA
jochen.muenker@georg.com
www.georg.com
Contact: Jochen Muenker

Gerref Industries Inc.
Belding, MI
gerrefmail@gerref.com
www.gerref.com
Contact: Ray Mutterspauh

GES-AGM USA
Parma, OH
hk@ges-agm.com
www.ges-agm.com
Contact: Hunter Kearney

GGET/Mid-South Central Extrusion Dies
Muscle Shoals, AL
rbehnke@geminigroup.net
www.geminigroup.net
Contact: Rob Behnke

GGET/Thumb Tool & Engineering
Bad Axe, MI
rbehnke@geminigroup.net
www.geminigroup.net
Contact: Rob Behnke

GGET/TRI-R Dies
Youngstown, OH
rbehnke@geminigroup.net
www.geminigroup.net
Contact: Rob Behnke

GHI Hornos Industriales SL
Galdakao, Bizkaia, Spain
aiportilla@ghihornos.com
www.ghihornos.com
Contact: Ana Portilla

GHI Smart Furnaces
Galdakao, Bizkaia, Spain
aiportilla@ghihornos.com
www.ghihornos.com
Contact: Ana Portilla

GIA Clecim Press
Albacete, Spain
gaspar.fernandez@giaet.com
www.giaet.com
Contact: Gaspar Fernandez

Gillespie & Powers Inc.
St. Louis, MO
imarsh@gillespiepowers.com
www.gillespiepowers.com
Contact: Ian Marsh

GLAMA Maschinenbau GmbH
Gladbeck, Germany
w.nowitzki@glama.de
www.glama.de
Contact: Werner Nowitzki

Globus S.r.l.
Torino, Italy
bruno.taraglio@globus-eng.com
www.globus-eng.com
Contact: Bruno Taraglio

GNA alutech inc.
Saint-Laurent, QC, Canada
kwright@gna.ca
www.gna.ca
Contact: Kaleb Wright

Gramm Technik GmbH
Ditzingen, Germany
info@gramm-technik.de
www.gramm-technik.de
Contact: K. Schiffner

Granco Clark, Inc.
Belding, MI
kevin.nink@grancoclark.com
www.grancoclark.com
Contact: Kevin Nink

Granutech – Saturn Systems
Grand Prairie, TX
sales@granutech.com
www.granutech.com
Contact: Sales

Graphite COVA GmbH
Rothenbach, Pegnitz, Germany
purshottam@graphitecova.com
www.graphitecova.com
Contact: Purshottam Tiwari

Greenerd Press & Machine Co.
Nashua, NH
sales@greenerd.com
www.greenerd.com
Contact: Thomas M. Lavoie

Haarslev Industries Press Technology GmbH & Co. KG
Remscheid, Germany
joerg.hoffmann@haarslev.com
www.haarslev.com
Contact: Jörg Hoffmann

Hastec Group Inc./ Hastec Rebs Inc.
St. Catharines, ON, Canada
hsiegmund@hastec.com
www.hastecgroup.com
Contact: Hardy Siegmund

Hatch
Montreal, QC, Canada
jean-denis.carrier@hatch.com
www.hatch.com
Contact: Jean-Denis Carrier

Hatch IAS
Aliquippa, PA
terry.gerber@hatch.com
www.hatch.com
Contact: Terry Gerber

Hazelett Corporation (Ebner Group)
Colchester, VT
hazelett@hazelett.com
www.hazelett.com
Contact: David Hazelett

HCT, part of Bloom Engineering
Düsseldorf, Germany
dhunzinger@bloomeng.com
www.bloomeng.de
Contact: Denis Hunzinger

Hencon B.V.
Uft, The Netherlands
pvanvuchelen@hencon.com
www.hencon.com
Contact: Peter Vanvuchelen

Herkules North America
Ford City, PA
r.curler@herkulesusa.com
www.herkulesusa.com
Contact: Robert Curler

Hertwich Engineering GmbH
Braunau, Austria
angelina.konrad@hertwich.com
www.hertwich.com
Contact: Angelina Konrad

Hindalco-Almex Aerospace Limited
Mumbai, Maharashtra, India
siddharth.manjrekar@adityabirla.com
www.hindalcoalmex.com
Contact: Siddharth Manjrekar

HMR Group AS
Sunde, Norway
anna.prestnes@hmr.no
www.hmr.no
Contact: Anna Prestnes



GLAMA

always
the durable
solution

Cost effective heavy duty
mobile equipment
for aluminium industries . . .

GLAMA Maschinenbau GmbH

Headquarters:
Hornstraße 19
D-45964 Gladbeck / Germany

Fon: +49 (0) 2043 9738 0
Fax: +49 (0) 2043 9738 50
email: info@glama.de

GLAMA USA Inc.

60 Helwig St., Berea, Ohio 44017

Fon: +1 877 452 6266
Email: sales@glama-us.com



Alphabetical List of Companies

HOWDEN Canada

Concord, ON, Canada
ron.carmichael@howden.com
www.howden.com
Contact: Ron Carmichael

HPI GmbH

Branau-Ranshofen, Austria
hpi@hpi.at
www.hpi.at
Contact: Rainer Edtmeier

Hubbard-Hall, Inc.

Waterbury, CT
fcarminholi@hubbardhall.com
www.hubbardhall.com
Contact: Fernando Carminholi

Hycast

Sunnalsora, Norway
hycast@hydro.com
www.hycast.no
Contact: Ola Furu

Hydro Aluminum Metals USA, LLC

Baltimore, MD
trond.gjellesvik@hydro.com
www.hydro.com
Contact: Trond Gjellesvik

IAS GmbH

Iserlohn, Germany
t.schaefer@ias-induction.com
www.ias-induction.com
Contact: Torsten Schäfer

Ichikawa North America

Peachtree Corners, GA
tom@extrusionsupplies.com
www.ik-felt.co.jp
Contact: Tom Nentwick

Idamex S.A. de C.V.

El Salto, Jalisco, Mexico
ggzepeda@idamex.com
www.idamex.com
Contact: Guillermo Zepeda

IMPEC AS

Øvre Årdal, Norway
post@impec.no
www.impec.no
Contact: Ståle Øvstetun

IMS Systems Inc.

Mars, PA
sales.usa@ims-gmbh.de
www.imssystem.com
Contact: Markus Forsch

Inductotherm Corp.

Rancocas, NJ
sales@inductotherm.com
www.inductotherm.com
Contact: Charlie Vivian

InfoSight Corporation

Chillicothe, OH
sales@infosight.com
www.infosight.com
Contact: Becky Dolan

Innoval Technology Ltd

Banbury, Oxon, U.K.
enquiries@innovaltec.com
www.innovaltec.com
Contact: Helen Forrest

Innovatherm

Butzbach, Germany
dmaiwald@innovatherm.de
www.innovatherm.de
Contact: Detlef Maiwald

INOEX

Lancaster, PA
ballen@inoex.com
www.inoex.com
Contact: Brad Allen

Insulation Specialties of America

Wanatah, IN
mikem@insulationspecialties.com
www.insulationspecialties.com
Contact: Mike Misch

Interall Srl

Fiorano, Modenese (MO), Italy
info@interallpublications.it
www.interall.it
Contact: sales

Interlub

Zapopan, Jalisco, Mexico
sergio.vazquez@interlub.com
interlub.com/en/industrial-lubricants/
aluminum-extrusion-lubricants/
Contact: Sergio Vasquez

International Thermal Systems, LLC

Milwaukee, WI
kurt.willms@itsllcusa.com
www.internationalthermal
systems.com
Contact: Kurt Willms

Irwin Car and Equipment

Irwin, PA
info@irwincar.com
www.irwincar.com

ISRA Vision Parsytec

Darmstadt, Germany
info@isravision.com
www.isravision.com
Contact: Jens Magenheimer

Italteco SRL

Fiorano, Modenese (MO), Italy
info@italteco.com
www.italteco.com
Contact: Walter Dalla Barba

ITW Pro Brands

Olathe, KS
dwooten@itwprobrands.com
www.itwprobrands.com
Contact: Dave Wooten

Janus Automation LLC

Bridgeville, PA
edgardo.labruna@
janusautomation.com
www.janusautomation.com
Contact: Ed La Bruna

Kabert Industries Inc.

Villa Park, IL
karl@kabert.com
www.kabert.com
Contact: Karl Hartman

Kampf Machinery Corporation

Windsor, CT
michael.schubert@kampf-usa.com
www.kampf-usa.com
Contact: Michael Schubert

Kautec Solutions

Banyoles, Spain
sales@kautec.net
www.kautec.net
Contact: Roger Blanch

Kennedy Eurotech Inc.

Newnan, GA
alkennedy@usa.net
www.alkennedy.net
Contact: Al Kennedy

Kind & Co., Edelstahlwerk GmbH & Co. KG

Wiehl, Germany
werner.haehnel@kind-co.de
www.kind-co.de
Contact: Werner Hähnel

KRAHE InfoSystems, Inc.

Rockford, MI
info@krahe-is.com
www.krahe-is.com
Contact: Kevin Rahe



THORPE TECHNOLOGIES INC

ENGINEERS · CONSTRUCTORS OF THERMAL PROCESSING EQUIPMENT
INDUSTRIAL FURNACES · THERMAL OXIDIZERS · COMBUSTION SYSTEMS

EQUIPMENT FOR THE ALUMINUM INDUSTRY



Equipment for the Aluminum Industry:

Sow Driers

Delacquering Systems

Charging Machines for scrap, billets or slabs

Melting and Holding Furnaces

Stationary, tilting, sidewell or round, top charged configurations

Homogenizing and Process Furnaces

Shuttle, Car Bottom, Box, and Continuous walking beam



QUALITY ENGINEERING AND CONSTRUCTION FOR PROVEN EQUIPMENT RELIABILITY AND PRODUCTIVITY



THORPE TECHNOLOGIES INC

ENGINEERS · CONSTRUCTORS OF THERMAL PROCESSING EQUIPMENT
INDUSTRIAL FURNACES · THERMAL OXIDIZERS · COMBUSTION SYSTEMS

449 W Allen Ave · Suite 119 · San Dimas, CA · 91773 · Phone (562) 903-8230 · FAX (562) 903-8236

www.thorpetech.com - sales@thorpetech.com

Alphabetical List of Companies

Lake Park Tool & Machine, Inc.

Youngstown, OH
 sales@lakepark.com
 www.lakepark.com
 Contact: Raymond Fryan

Laserax

Quebec, QC, Canada
 jboneron@laserax.com
 www.laserax.com
 Contact: Jean-Benoit Néron

Lethiguel

Lentilly, France
 sales.france@lethiguel.com
 www.lethiguel.org
 Contact: Sales Team

LINDE

Danbury, CT
 valmiro.correia@linde.com
 www.lindeus.com
 Contact: Valmiro Correia

LOI Thermprocess GmbH

Duisburg, Germany
 service-loi@tenova.com
 www.loi.tenova.com
 Contact: Hartwig Thie

Long Point Associates

Summerville, SC
 lfbrown257@gmail.com
 Contact: Lynn Brown

Lyng Drilling AS

Vanvikan, Norway
 lyngsales@slb.com
 www.lyng-drilling.com
 Contact: Hans Seehuus

Machinery International Corp.

Woodbridge, CT
 sales@machyintl.com
 www.machyintl.com
 Contact: Steve McMillan

Macrodyne Technologies Inc.

Concord, ON, Canada
 sales@macrodynepress.com
 www.macrodynepress.com
 Contact: Kevin Fernandes

Major Furnace Australia Pty. Ltd.

Clayton South, VIC, Australia
 major@majoreng.com.au
 www.majoreng.com.au
 Contact: Geoff Peacock

Mansell and Associates, LLC

Tuscumbia, AL
 emansell@

mansellandassociates.net
 www.mansellandassociates.net
 Contact: Ed Mansell

MARX GmbH & Co. KG

Iserlohn, Germany
 info@marx-gmbh.de
 www.marx-gmbh.de
 Contact: Christian Eckenbach

MARX LLC

Youngstown, OH
 sales@marx-us.com
 www.marx-us.com
 Contact: Christian Eckenbach

Matalco Inc.

Brampton, ON, Canada
 rroschetti@matalco.com
 www.matalco.com
 Contact: Robert Roscetti

Mechatherm International Limited

Kingswinford, U.K.
 mark.allen@mechatherm.co.uk
 www.mechatherm.com
 Contact: Mark Allen

Mersen USA GS Corp—Greenville

Greenville, MI
 sales.greenville@mersen.com
 www.graphite-eng.com
 Contact: Sales

Messer Americas

Bridgewater, NJ
 sales@messer-us.com
 www.messer-us.com
 Contact: Inside Sales

Metal Star Consulting LLC

Edgar, WI
 johnny@metalstarconsulting.com
 www.metalstarconsulting.com
 Contact: Johnny Pangborn

MetALLsource, LLC

Saegertown, PA
 candi.vantuil@metallsource.com
 www.metallsource.com
 Contact: Candi VanTuil

MINO SpA

Alessandria, Italy
 sales@mino.it
 www.mino.it
 Contact: Nicola Gioachin

Molten Metal Equipment Innovations

Middlefield, OH
 info@mmei-inc.com
 www.mmei-inc.com

Contact: Sarah Mikash

Motultech Baraldi

Bologna, Italy
 martin.hartlieb@baraldi.com
 www.baraldi.com
 Contact: Martin Hartlieb

MQP Limited

Old Tappen, NJ
 johnvj@optonline.net
 www.mqpltd.com
 Contact: John Griffin

Murlin Chemical Inc.

West Conshohocken, PA
 tom@murlinchemical.com
 www.murlinchemical.com
 Contact: Thomas Brett

N.T.K Plants Management & Business Initiating Ltd.

Shkhamya, D.N. Misgav, Israel
 elgad@netvision.net.il
 Contact: Tuvia Kornfeld

National Machinery Exchange, Inc.

Newark, NJ
 brian@nationalmachy.com
 www.nationalmachy.com
 Contact: Brian Epstein

Nitrex Metal Inc.

Montreal, QC, Canada
 sales@nitrex.com
 www.nitrex.com
 Contact: Jack Kalucki

Nitrex Metal Sp. Z.o.o.

Sosnowiec, Poland
 nitrex.europe@nitrex.com
 www.nitrex.com
 Contact: Marcin Stoklosa

Northern Innovations

Niagara Falls, NY
 stephen@northerninnovations.net
 www.northerninnovations.net
 Contact: Stephen Wasilenko

Novatec Innovative Solutions

Surrey, B.C., Canada
 ssuciu@novatecpro.com
 www.novatecpro.com
 Contact: Sorin Suci

Novelis PAE

Voreppe Cedex, France
 pae.marketing@novelis.adityabirla.com
 www.novelispae.com
 Contact: Jean-Christophe Garcin

Alphabetical List of Companies

O2 Environmental Technologies Inc.

Chapel Hill, NC
info@qamanage.com
www.qamanage.com
Contact: Randal Galloway

Oculatus Consulting

Greenacres, WA
bob.wagstaff@oculatusconsulting.com
www.oculatusconsulting.com
Contact: Bob Wagstaff

OMAV S.P.A.

Rodengo Saiano (BS), Italy
sales@omav.com
www.omav.com
Contact: Sales Team

Otto Junker GmbH

Simmerath, Germany
info@otto-junker.com
www.otto-junker.com
Contact: Sales

PerenniAL Group

Rye Brook, NY
info@theperennial-group.com
www.theperennial-group.com
Contact: James Walters

Phipps Company

Roxboro, NC
sales@phippsmetals.com
www.phippsmetals.com
Contact: Ron Phipps

Phoenix International SpA

Verdello, Italy
rmaffioletti@phoenix-spa.com
www.phoenix-spa.com
Contact: Roberto Maffioletti

Pittek Div., Swindell Dressler Intl.

Coraopolis, PA
tschultz@swindelldressler.com
www.pittek.com
Contact: Tim Schultz

Plibrico Company

Salem, OH
contact@plibrico.com
www.plibrico.com
Contact: Customer Support

Powder Coating Institute

Lakewood Ranch, FL
kevin@powdercoating.org
www.powdercoating.org
Contact: Kevin Coursin

PPG

Pittsburgh, PA
ic-na@ppg.com
www.ppgindustrialcoatings.com
Contact: Desiree Miller

Praxair Surface Technologies, a Linde Company

Indianapolis, IN
michael.brennan@linde.com
www.praxairsurfacetechologies.com
Contact: Michael Brennan

Precimeter Control AB

Gothenburg, Sweden
sales@precimeter.com
www.precimeter.com
Contact: Jonatan Lindstrand

Precimeter Inc.

Tempe, AZ
usa@precimeter.com
www.precimeter.com
Contact: Jerry Wilkins

Prezezi Extrusion – Melting Technology Division

Vimercate (MB), Italy
g.battino@prezeziextrusion.com
www.prezeziextrusiongroup.com
Contact: Giovanni Battino

Prezezi Extrusion Group

Vimercate (MB), Italy
info@prezeziextrusion.com
www.prezeziextrusiongroup.com
Contact: Manuela Beretta

Prezezi Extrusion North America

Morton Grove, IL
b.donada@prezeziextrusion.com
www.prezeziextrusiongroup.com
Contact: Bruno Donada

Primetals Technologies

Canonsburg, PA
contact@primetals.com
www.primetals.com
Contact: Keith Orawiec

Properzi International, Inc.

Sparks, MD
m.cerasi@properzi.us
www.properzi.com
Contact: Giuseppe Marcantoni

Pyrotek

Spokane, WA
davcol@pyrotek.com
www.pyrotek.com
Contact: David Cole

QForm Group

Oxford, U.K.
market@qform3d.com
www.qform3d.com
Contact: Sales

Quaker Houghton

Conshohocken, PA
ryan.paul@quakerhoughton.com
home.quakerhoughton.com
Contact: Ryan Paul

Quickdraft

Canton, OH
twp@quickdraft.com
www.quickdraft.com
Contact: Travis Powell

R.L. Best Company

Boardman, OH
j.best@rlbest.com
www.rlbest.com
Contact: Jeff Best

R&D Carbon Ltd.

Granges, Switzerland
info@rd-carbon.com
www.rd-carbon.com
Contact: Dr. Markus Meier

Ramboll

Liverpool, NY
taylor.rector@ramboll.com
americas.ramboll.com/advanced-manufacturing
Contact: Taylor Rector

Red Bud Industries

Red Bud, IL
dlinders@redbudindustries.com
www.redbudindustries.com
Contact: Dean Linders

REDWAVE, a div of BT - Wolfgang Binder GmbH

Eggersdorf bei Graz, Austria
angela.thaller@redwave.com
www.redwave.com
Contact: Angela Thaller

Refractory Technology LLC

Las Vegas, NV
thehunz@aol.com
www.refractorytechllc.com
Contact: Jay W. Hunzinker

Regain Materials

Melbourne, VIC, Australia
info@regainmaterials.com
www.regainmaterials.com
Contact: Bernie Cooper

Alphabetical List of Companies

Reliant Aluminum Products, LLC
High Point, NC
cparker@reliantaluminum
products.com
www.reliantaluminumproducts.com
Contact: Chris Parker

RFTS LLC
Higganum, CT
rftsii@aol.com
www.linkedin.com/in/louisnizet
Contact: Louis Nizet

RIA Cast House Engineering GmbH
Leipzig, Germany
james.tomkinson@ria-che.de
www.ria-che.com
Contact: James Tomkinson

Riedhammer GmbH
Nuremberg, Germany
thomas.janousch@riedhammer.de
www.riedhammer.de
Contact: Thomas Janousch

Rigaku Analytical Devices
Wilmington, MA
jen.lynych@rigaku.com
www.rigakuanalytical.com
Contact: Jen Lynch

Rio Tinto
Montreal, QC, Canada
sales@riotinto.com
www.riotinto.com/
aluminium-83.aspx
Contact: Sales

Sanshin Industry Ltd.
Kobe-shi Hyogo-ken, Japan
jack@sanshinkogyo.jp
www.sanshinindustry.com
Contact: Jack Rushlander

SAT North America
Indianapolis, IN
sales@sataluminium.com
www.sataluminium.com
Contact: Alessandro Guerrini

SCCR P/L
Brisbane, Australia
irjacobson@sccrgroup.com
www.sccrgroup.com
Contact: Ian R. Jacobson

Scottish Chemical Industries
Mumbai, Maharashtra, India
rishab@scottishchemical.com
www.scottishchemical.com
Contact: Rishab Khandelwal

SECO/Warwick Corp.
Meadville, PA
marcus.lord@secowarwick.com
www.secowarwick.com
Contact: Marcus Lord

Sensory Analytics (SpecMetrix Systems)
Greensboro, NC
greg.frisby@specmetrix.com
www.specmetrix.com
Contact: Greg Frisby

SenTek Corporation
Columbus, OH
info@sentekcorp.com
www.sentekcorp.com
Contact: Jackie Racicot

Sermas
St. Quentin sur Isere, France
sermas@sermas.com
www.sermas.com
Contact: Gérard Laforet

SGL Carbon GmbH – Graphite Solutions
Weisbaden, Germany
gs-europe@sglcarbon.com
www.sglcarbon.com/en
Contact: Sales

Siddharth Heavy Industries Pvt. Ltd.
Mache, Belgaum, Karnataka, India
siddhartindus@gmail.com
www.siddharthindustries.com
Contact: Prashant Jadhav

Sistem Teknik Industrial Furnaces Ltd.
Cayirova, Kocaeli, Turkey
sales.alu@sistemteknik.com
www.sistemteknik.com/non-ferrous
Contact: Ayse Obali

SMS group GmbH
Moenchengladbach, Germany
info@sms-group.com
www.sms-group.com
Contact: Sales

SMS group, Inc.
Pittsburgh, PA
info@sms-group.com
www.sms-group.us
Contact: John Bergman

Southeastern Extrusion & Tool
Florence, AL
orders@set-tool.com
www.set-tool.com
Contact: Wilbur Craven/ Mike Moody

Southwire SCR Technologies
Carrollton, GA
mike.gallagher@southwire.com
www.southwire.com
Contact: Mike Gallagher

Starcut SRL
Cormano, Milan, Italy
starcut@starcut.it
www.starcut.it
Contact: Laura Felisari

STAS
Chicoutimi, QC, Canada
info@stas.com
www.stas.com
Contact: Mélanie Simard

Stedman Machine Company
Aurora, IN
sales@stedman-machine.com
www.stedman-machine.com
Contact: Sales

Stines Equipment Company
Medina, TN
stinesequipment@gmail.com
Contact: Tom Stines

Surface Combustions, Inc.
Maumee, OH
info@surfacecombustion.com
www.surfacecombustion.com
Contact: Ben Bernard

T.T. Tomorrow Technology S.p.A.
Due Carrare (PD), Italy
elena.fincato@tomorrowtechnology.it
www.tomorrowtechnology.it
Contact: Elena Fincato

Taber Industries
North Tonawanda, NY
sales@taberindustries.com
www.taberindustries.com
Contact: Alan Jaenecke

Techmo Car SpA
Limena, PD, Italy
elena.battan@techmo.it
www.techmo.com
Contact: Elena Battan

Termia Technology Corporation
Deerfield Beach, FL
chg@termia.net
www.termia.net
Contact: Claudio Goldbach

Billet / Ingot Casting Consumables!



Vacuum Forming Parts

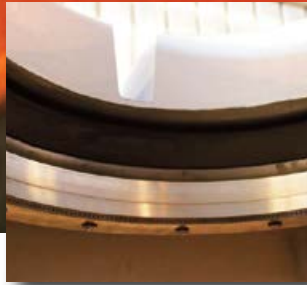

Graphite Ring Installed in Billet Casting Mold



"Special" Table Top Linings



UltraTemp-AL® Transition Plates
Increasing the number of casts per plate

Consumable products for non-ferrous metal.

- Transition Plates
- Engineered Casting Parts
- Header Pots
- Moldable Ceramic Paste
- Vacuum Formed Boards & Shapes
- Graphite Rings & Specialty Parts
- Induction Aluminum Melting Equip.
- Power Cables, Coils, Power Supplies
- Molten Metal Contact



REFRACTORY
TECHNOLOGY LLC

Cell: 760-220-1524

email: thehunz@aol.com

email: thehunz124@gmail.com

www.RefractoryTechLLC.com

Las Vegas, NV 89145, USA

Alphabetical List of Companies

The Aluminum Association

Arlington, VA
mmeen@aluminum.org
www.aluminum.org
Contact: Matt Meenan

The Gund Company Inc.

St. Louis, MO
flugo@thegundcompany.com
www.thegundcompany.com
Contact: Freddy Lugo

The L.S. Starrett Co.

Athol, MA
general@starrett.com
www.starrett.com

The Oilgear Company

Traverse City, MI
ussales@oilgear.com
www.oilgear.com
Contact: Sales

Thermika Systems Inc.

Maple Ridge, BC, Canada
charbel@thermikasytems.com
www.thermikasytems.com
Contact: Charbel Saliba

Thorpe Technologies Inc.

San Dimas, CA
imarsh@thorpetech.com
www.thorpetech.com
Contact: Ian Marsh

TMS (The Minerals, Metals & Materials Society)

Pittsburgh, PA
publications@tms.org
www.tms.org
Contact: Matt Baker

TOMRA Sorting Inc.

Charlotte, NC
recycling.us@tomra.com
www.tomra.com
Contact: Eric Thurston

TotalEnergies Marketing USA

Linden, NJ
daryl.foley@totalenergies.com
www.services.us.totalenergies.com/
totalenergies-marketing-usa-inc
Contact: Daryl Foley

Tuff Temp Corp.

Quakertown, PA
bgoldberg@tufftemp.com
www.tufftemp.com
Contact: Brett Goldberg

Turla Extrusion Plants FFK S.R.L

Paderno Franciacorta (BS), Italy
sales@rfk-extrusion.com
www.turla.it
Contact: Stefania Venturi

UBE Machinery

Ann Arbor, MI
jcobb@ubemachinery.com
www.ubemachinery.com
Contact: John Cobb

Uddeholm USA

Elgin, IL
sales.usa@uddeholm.com
www.uddeholm.com/usa
Contact: Kevin Rochford

Ultra-Sonic Extrusion Dies Inc.

Clinton Township, MI
engdept@usedies.com
www.usedies.com
Contact: David Schoenegge

United States Controls

Poland, OH
customerservice@
unitedstatescontrols.com
www.unitedstatescontrols.com
Contact: Rod Christensen

Urja Products Pvt. Ltd.

Ahmedabad, Gujarat, India
export@urjafabrics.com
www.urjafabrics.com
Contact: Mamta Dand

voestalpine eifeler coatings

St. Charles, IL
jim.clay@eifeler.com
www.eifeler.com/northamerica
Contact: Jim Clay

Wagstaff, Inc.

Spokane, WA
Meng.yu@wagstaff.com
www.wagstaff.com
Contact: Meng Yu

Wahl Refractory Solutions, LLC

Fremont, OH
info@wahlref.com
www.wahlref.com
Contact: Geoff Perdue

WEFA Cedar Inc.

Cedar Springs, MI
fred.cini@wefa.com
www.wefa.com
Contact: Fred Cini

Wendt Corporation

Buffalo, NY
sales@wendtcorp.com
www.wendtcorp.com
Contact: Val Andrews

Williamson Corp.

Concord, MA
bbarron@williamsonir.com
www.williamsonir.com
Contact: Bill Barron

WorleyParsons Services Pty. Ltd.

Geelong, VIC, Australia
scott.grant@worleyparsons.com
www.worleyparsons.com
Contact: Scott Grant

Youngstown Tool & Die Co. LLC

Youngstown, OH
davem@youngstowntool.com
www.youngstowntool.com
Contact: David Mrdjjenovic

ZIRCAR Ceramics, Inc.

Florida, NY
dph@zircarceramics.com
www.zircarceramics.com
Contact: David Hamling

Zmag America, Ltd.

Portland, OR
info@zmag.net
www.zmag.net
Contact: Eishin Takahashi

ZYP Coatings, Inc.

Oak Ridge, TN
info@zypcoatings.com
www.zypcoatings.com
Contact: C.E. Holcombe

The Magnetic Engineering Firm



Zmag

Introducing MagPump™

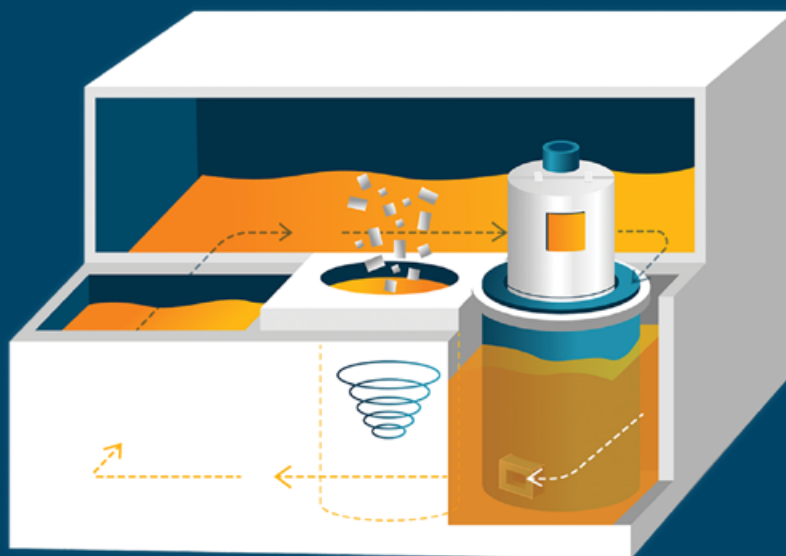

Mechanical Pump Replacement

- **No Consumable Parts**
- **No Furnace Modification**
- **Maintenance Free**
- **No Downtime**
- **Hands-free**

www.zmag.net

info@zmag.net



See the MagPump video!



Chiz Bros: Refractory and Insulation Specialists



**Need an Aluminum Melting Furnace
Door Relined? Give us a call!**

Full Inventory of:

Ceramic Fiber Blanket | Modules | Paper | Rope

Detroit Warehouse Now Open

Chiz Bros
Refractory and Insulation Specialists
412-384-5220 • www.chizbros.com
Elizabeth, PA 15037

